

修 订 REV NO	标 记 MARK	修 改 描 述 REVISON DESCRIPTION	签 名 SIGNATURE	日 期 DATE
		NEW DRG		2016-03-12

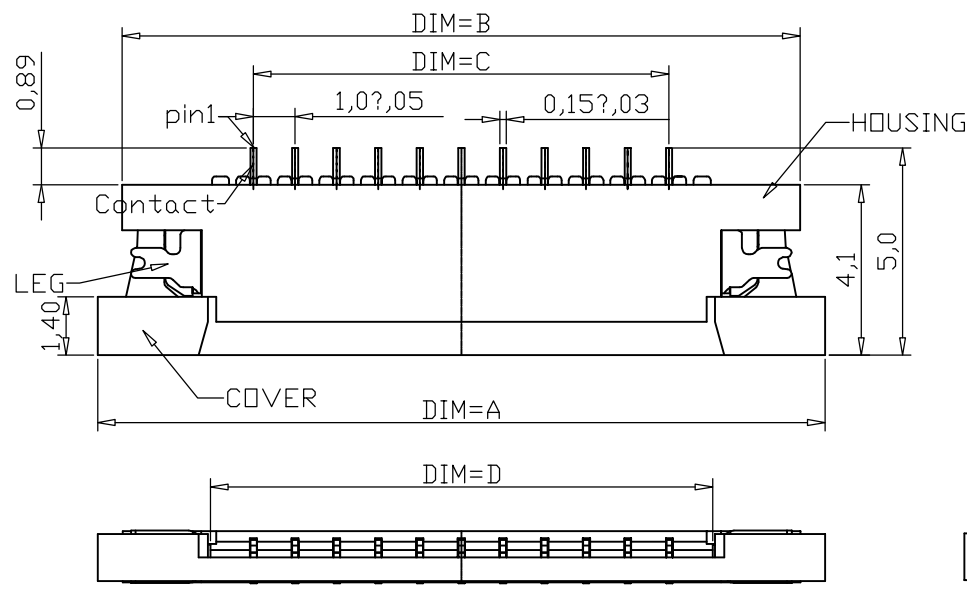

NOTES:

- MATERIAL:  
HOUSING: LCP UL 94V-0, COLOR:NATURE  
ACTUATOR: LCP UL 94V-0, COLOR:BLACK  
TERMINAL: PHOSPHOR BRONZE  
STOPPER: BRASS
- PLATING:  
TERMINAL: TIN OVER NICKEL  
STOPPER: TIN OVER NICKEL
- PATING:  
CURRENT RATING:0.4A (AC/DC)  
OPERATING VOLTAGE:50V (AC/DC)  
OPERATING TEMPERATURE: -55°C~+85°C

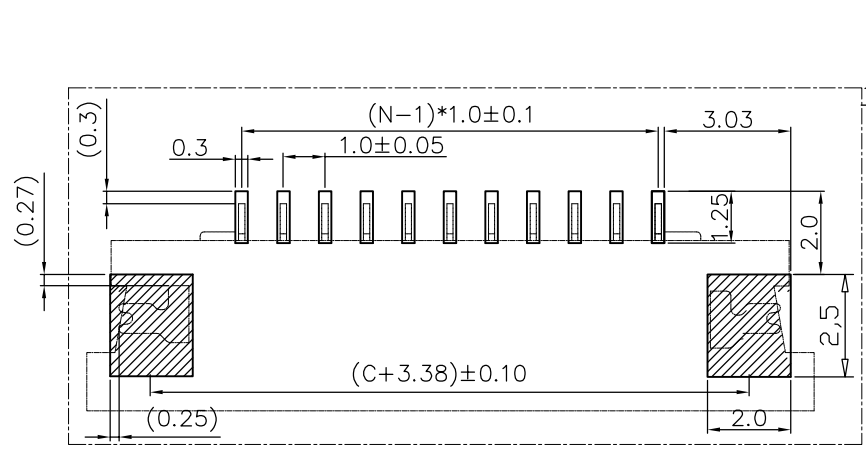

RECOMMENDED PCB LAYOUT  
TOLERANCE:±0.05

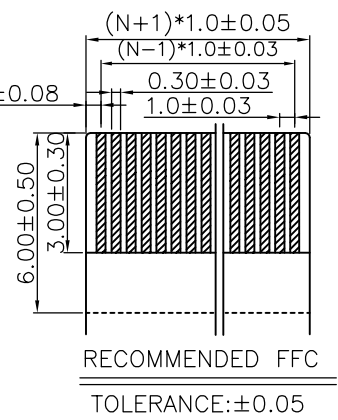
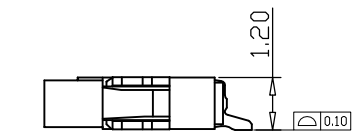



RECOMMENDED FFC  
TOLERANCE:±0.05

PIN	DIM, A	DIM, B	DIM, C	DIM, D
04	10.50	9.30	3.00	5.08
05	11.50	10.30	4.00	6.08
06	12.50	11.30	5.00	7.08
07	13.50	1.30	6.00	8.08
08	14.50	13.30	7.00	9.08
09	15.50	14.30	8.00	10.08
10	16.50	15.30	9.00	11.08
11	17.50	16.30	10.00	12.08
12	18.50	17.30	11.00	13.08
24	30.50	29.30	23.00	25.08
26	32.50	31.30	25.00	27.08



深圳市华德共创科技有限公司  
Shenzhen Huade co-create Technology Co.,LTD  
电话: 0755-27111225 传真: 0755-29940187

-TOLERANCES- UNLESS OTHERWISE SPECIFIED 公差参数表		 	TITLE: 产品名称: FPC 1.0间距1.2高上接抽展式					
X.X	±0.30	X.X°	±3°	APPD: 核准:		PART NO: 产品编号: 1.0K-1.2S-nPWB		
X.XX	±0.20	X.XX°	±2°	CHECK: 校对: 王建业	DATE	SCALE	UNIT	CODE NUMBER
X.XXX	±0.10	X.XXX°	±1°	DRAW: 绘图: 黄艳兰	2016-03-12	1:1	mm	A001