

# 59135 High Temperature Flange Mount Sensor

## Flange Mounting Sensor

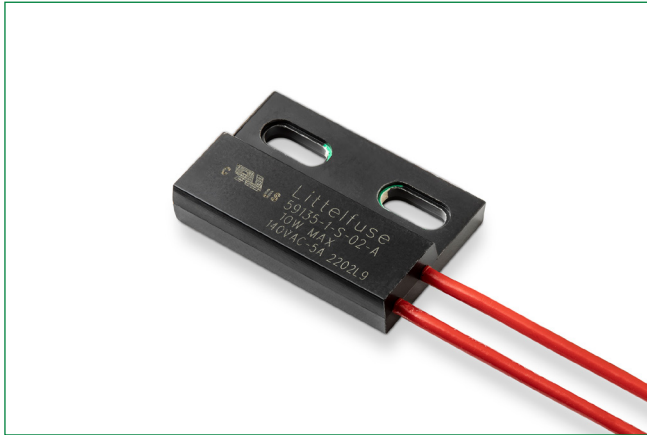

### Description

The 59135 is a high temperature flange mounting reed sensor 28.57mm x 19.05mm x 6.35mm (1.125" x 0.750" x 0.250") with a choice of normally open, normally closed or change-over contacts. The case design enables mounting with M3 screw with washer at 1 Nm torque maximum or adhesive mounting. It is rated for operation up to 150°C and capable of switching up to 265Vac/300Vdc at 10VA.

The 59135 series is well suited for use in a wide range of industrial, appliances, or IoT proximity sensing applications.

**Note:** The 59135 series functions best with the matching actuator 57135-000.

### Features and Benefits

- Non-contact switching solution for wet & harsh environments
- Rated up to 150C operating temperature
- Housing design for optimum adjustability
- Available in select sensitivities (operating distances)
- Standard Teflon insulated cable configurations; customization options available
- Thermoset overmold material
- Hermetically sealed, IP67 rated; UL and REACH compliant
- No leakage current in 'open' state—ideal for battery powered IoT applications
- Can operate through non-ferrous materials (for example, wood, plastic or aluminium)
- Helps implement efficient proximity/access and energy management systems
- Compact size and easy installation and effective concealment in many applications
- UL Recognized per UL 508 and CSA C22.2 No. 14.

### Additional Information



Resources



Accessories



Samples

### Dimensions

Dimensions in mm (inch)

Tolerances are +/- 0.25 (0.010) unless otherwise noted.

#### Actuator

(sold separately)

#### Drawing 1

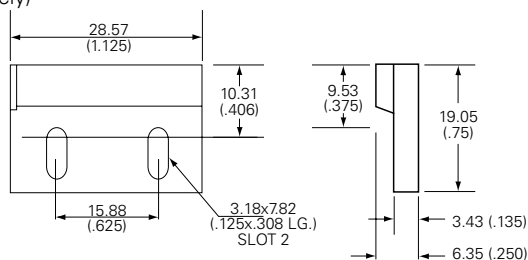

#### Sensor

#### Drawing 2

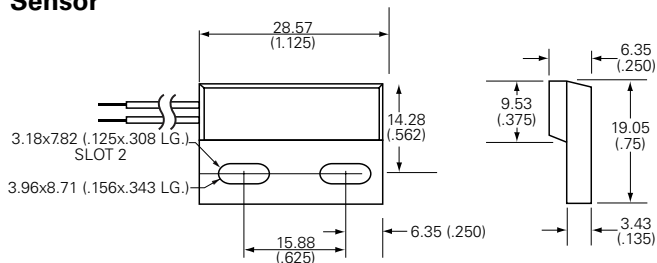

Table 1

Schematics	Switch Type
Red Red	1 and 2
Red Blue White	3
Red Red	4

### Applications

- Security and access control
- Factory automation
- Process equipment
- Major appliances
- Small appliances
- Proximity and limit sensing

Table 2  
Agency Approvals

Agency	Agency File Number
	E61760

**Note:** Contact Littelfuse for specific agency approval ratings.

# 59135 High Temperature Flange Mount Sensor

## Flange Mounting Sensor

**Table 3**  
**Electrical Ratings**

Contact Type			Normally Open	Normally Open High Voltage	Change Over	Normally Closed
Switch Type			1	2	3	4
Contact Rating <sup>1</sup>		VA/Watt - max.	10	10	5	5
Voltage <sup>4</sup>	Switching <sup>2</sup>	Vdc - max.	200	300	175	175
		Vac - max.	140	265	120	120
	Breakdown <sup>3</sup>	Vdc - min.	250	400	200	200
Current <sup>4</sup>	Switching <sup>2</sup>	Adc - max.	0.5	0.4	0.25	0.25
		Aac - max.	0.35	0.30	0.18	0.18
	Carry	Adc - max.	1.2	1.4	1.5	1.5
Resistance <sup>5</sup>	Contact, Initial Insulation	Ω - max.	0.2	0.2	0.2	0.2
		Ω - min.	10 <sup>10</sup>	10 <sup>10</sup>	10 <sup>9</sup>	10 <sup>9</sup>
Capacitance	Contact	pF - typ.	0.3	0.2	0.3	0.3
Temperature	Operating	°C	-40 to +150	-20 to +150	-40 to +150	-40 to +150

**Table 4**

Product Characteristics						
Operate Time <sup>6</sup>		ms - max.	1.0	1.0	3.0	3.0
Release Time <sup>6</sup>		ms - max.	1.0	1.0	3.0	3.0
Shock <sup>7</sup>	11ms ½ sine	G - max.	100	100	50	50
Vibration <sup>7</sup>	50-2000 Hz	G - max.	30	30	30	30

**Notes:**

- Contact rating - Product of the switching voltage and current should never exceed the wattage rating. Contact Littelfuse for additional load/life information.
- When switching inductive and/or capacitive loads, the effects of transient voltages and/or currents should be considered. Refer to Application Notes AN108A and AN107 for details.
- Breakdown Voltage - per MIL-STD-202, Method 301.
- Electrical Load Life Expectancy - Contact Littelfuse with voltage, current values along with type of load.
- This resistance value is for 300 mm wire length. Resistance changes when wire lengthens.
- Operate (including bounce)/Release Time - per EIA/NARM RS-421-A, diode suppressed coil (Coil III).
- Shock and Vibration - per EIA/NARM RS-421-A and MIL-STD-202.
- For custom modifications to the wire length or size, or adding a special connector, please contact Littelfuse.

**Table 5**  
**Sensitivity Options (Using 57135 Actuator)**

Select Option	S			T			U			V		
	Pull-In AT Range	Activation Distance (mm)	Deactivation Distance (mm)	Pull-In AT Range	Activation Distance (mm)	Deactivation Distance (mm)	Pull-In AT Range	Activation Distance (mm)	Deactivation Distance (mm)	Pull-In AT Range	Activation Distance (mm)	Deactivation Distance (mm)
1 Normally Open	12-18	11-23	13-25	17-23	10-22	12-24	22-28	8-20	10-22	27-33	6-18	9-21
2 High Voltage	-	-	-	17-23	8-20	11-23	22-28	7-19	11-23	27-33	6-18	10-22
3 Change Over	15-20	9-21	11-23	20-25	6-18	9-21	25-30	5-17	8-20	-	-	-
4 Normally Closed	15-20	9-21	11-23	20-25	6-18	9-21	25-30	5-17	8-20	-	-	-

**Notes:**

- Pull-In AT Range: These AT values are the bare reed switch AT before modification.
- The activation distance is average value on the final sensor assembly.

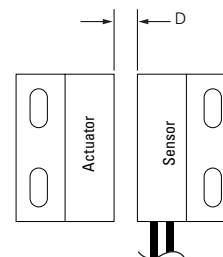

# 59135 High Temperature Flange Mount Sensor

## Flange Mounting Sensor

**Table 6**  
**Cable Length Specification**

Cable Type: 20 AWG 19/32 FEP UL1130/UL1332	
Select Option	Cable Length mm (inch)
02	300 +/-10.00 (11.81 +/- 0.394)
05	1000+/-10.00 (39.37+/- 0.394)

**Table 7**  
**Termination Specification**

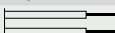
Termination Options		
Select Option	Description (Two-wire versions illustrated)	
A	Tinned leads (6.4±0.76)mm	

**Table 8**  
**Material Specification**

	Housing Material	Color	Sealing Component
57135 Actuator	Thermoset Epoxy	Black	Epoxy
59135 Sensor	Thermoset Epoxy	Black	Epoxy

**Table 9**  
**Packaging**

Cable Length	Packaging Option	Quantity
02	Bulk	500
05	Bulk	500

**Part Numbering System**

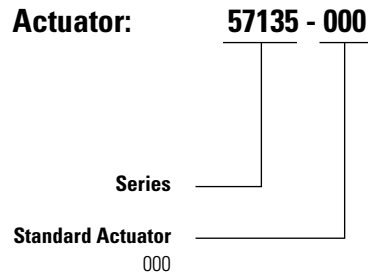
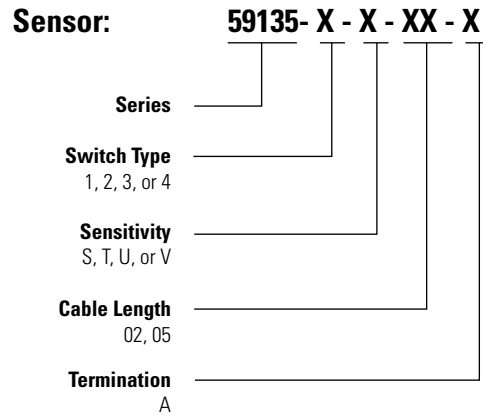

**Note:** The 57135 Actuator is sold separately.

# Mouser Electronics

Authorized Distributor

Click to View Pricing, Inventory, Delivery & Lifecycle Information:

## Littelfuse:

[59135-010](#) [59135-020](#) [59135-1-S-02-F](#) [59135-2-V-02-F](#) [59135-030](#) [59135-3-T-02-A](#) [59135-040](#) [59135-2-U-05-F](#)  
[59135-2-S-02-E](#) [59135-2-T-05-F](#) [59135-2-S-03-E](#) [59135-2-V-05-F](#) [59135-2-S-04-C](#) [59135-2-S-03-D](#) [59135-2-S-05-F](#)  
[59135-2-S-05-D](#) [59135-2-S-04-A](#) [59135-2-S-01-A](#) [59135-2-S-01-C](#) [59135-2-S-02-F](#) [59135-2-S-03-A](#) [59135-2-S-02-](#)  
[A](#) [59135-2-S-05-C](#) [59135-1-T-05-F](#) [59135-2-S-04-D](#) [59135-2-S-03-F](#) [59135-2-S-04-E](#) [59135-3-S-05-F](#) [59135-2-S-](#)  
[02-D](#) [59135-2-S-01-D](#) [59135-2-S-01-F](#) [59135-2-S-02-C](#) [59135-2-S-05-A](#) [59135-1-U-05-F](#) [59135-1-V-05-F](#) [59135-2-](#)  
[S-04-F](#) [59135-2-S-01-E](#) [59135-2-S-03-C](#) [59135-2-S-05-E](#) [59135-4-U-05-F](#) [59135-3-T-05-F](#) [59135-4-T-05-F](#) [59135-](#)  
[3-U-05-F](#) [59135-3-V-03-A](#) [59135-3-V-01-A](#) [59135-3-V-05-A](#) [59135-4-V-05-D](#) [59135-3-V-05-E](#) [59135-4-V-02-F](#)  
[59135-4-V-04-F](#) [59135-3-V-02-C](#) [59135-3-V-03-D](#) [59135-4-V-02-A](#) [59135-4-V-03-F](#) [59135-4-V-05-F](#) [59135-4-V-05-A](#)  
[59135-3-V-04-F](#) [59135-4-V-01-E](#) [59135-4-V-01-D](#) [59135-4-V-03-D](#) [59135-3-V-02-D](#) [59135-3-V-05-C](#) [59135-4-V-03-](#)  
[A](#) [59135-3-V-01-E](#) [59135-3-V-03-E](#) [59135-4-V-04-D](#) [59135-3-V-01-F](#) [59135-3-V-02-A](#) [59135-3-V-02-E](#) [59135-4-V-](#)  
[04-A](#) [59135-4-V-02-D](#) [59135-4-V-02-E](#) [59135-3-V-02-F](#) [59135-3-V-01-C](#) [59135-3-V-05-D](#) [59135-4-V-01-C](#) [59135-4-](#)  
[V-05-E](#) [59135-4-V-05-C](#) [59135-4-V-01-F](#) [59135-3-V-04-D](#) [59135-4-V-03-E](#) [59135-4-V-02-C](#) [59135-4-V-04-C](#) [59135-](#)  
[3-V-04-C](#) [59135-4-V-04-E](#) [59135-3-V-01-D](#) [59135-4-V-03-C](#) [59135-3-V-04-A](#) [59135-3-V-04-E](#) [59135-4-V-01-A](#)  
[59135-3-V-03-F](#) [59135-3-V-05-F](#) [59135-3-V-03-C](#)