



# 安徽富信半导体科技有限公司

ANHUI FOSAN SEMICONDUCTOR TECHNOLOGY CO., LTD.

DB3W

## SOD-123FL Trigger Diode 触发二极管

### ■ Features 特点

Bidirectional Trigger 双向触发

Thyristor phase control 可控硅导通角控制

For lamp-dimming, universal-motor speed controls

用于台灯调光及无刷马达速度控制

Marking 印字: DB3



### ■ Maximum Rating 最大额定值

( $T_A=25^{\circ}\text{C}$  unless otherwise noted 如无特殊说明, 温度为  $25^{\circ}\text{C}$ )

Characteristic 特性参数	Symbol 符号	Rating 额定值	Unit 单位
Repetitive Peak On-state Current@ $t_p=20\mu\text{s}, f=100\text{Hz}$ 重复峰值通态电流	$I_{TRM}$	2	A
Power Dissipation 耗散功率	$P_D$	150	mW
Thermal Resistance Junction-Ambient 结到环境热阻	$R_{\theta JA}$	833	$^{\circ}\text{C}/\text{W}$
Junction/Storage Temperature 结温/储藏温度	$T_J, T_{stg}$	-40to+125 $^{\circ}\text{C}$	$^{\circ}\text{C}$

### ■ Electrical Characteristics 电特性

( $T_A=25^{\circ}\text{C}$  unless otherwise noted 如无特殊说明, 温度为  $25^{\circ}\text{C}$ )

Characteristic 特性参数	Symbol 符号	Min 最小值	Max 最大值	Unit 单位
Breakover Voltage 转折电压 @ $C = 22\text{ nF}$ , see diagram 1	$V_{BO}$	28	36	V
Breakover Voltage Symmetry 转折电压偏差 @ $C = 22\text{ nF}$ , see diagram 1	$[ +V_{BO} - V_{BO} ]$		3	V
Dynamic Breakover Voltage 动态转折电压 @ $\Delta I = [I_{BO} \text{ to } I_F = 10\text{ mA}]$	$ \Delta V_{\pm} $	5		V
Output Voltage 输出电压 See diagram 2	$V_O$	5		V
Breakover Current 转折电流 @ $C = 22\text{ nF}$	$I_{BO}$		50	$\mu\text{A}$
Leakage Current @ $V_B=0.5V_{BO}$	$I_B$		10	$\mu\text{A}$
Rise Time 上升时间 See diagram 3	$T_r$		2	$\mu\text{s}$

## ■ Typical Characteristic Curve 典型特性曲线

Diagram1: current-voltage characteristic

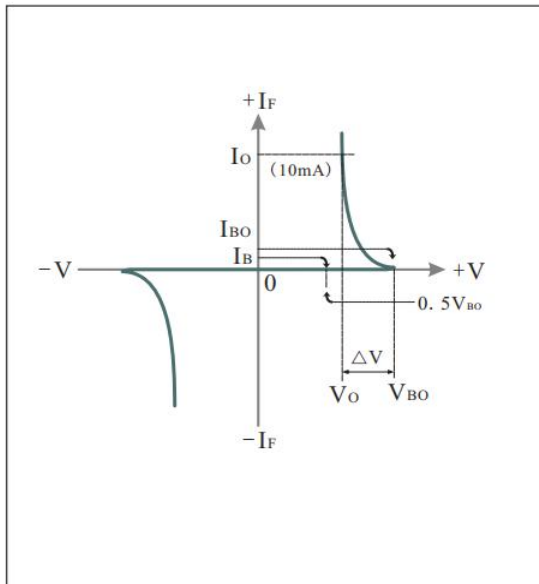

Diagram2: Test circuit for output voltage

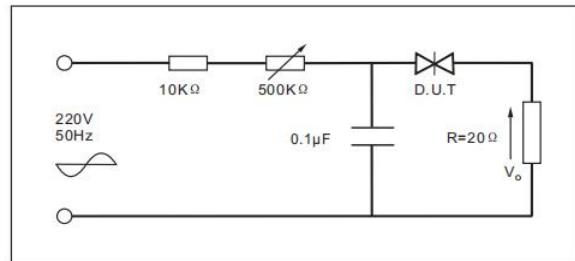

Diagram3: Test circuit see Fig.2. Adjust R for Ip=0.5A

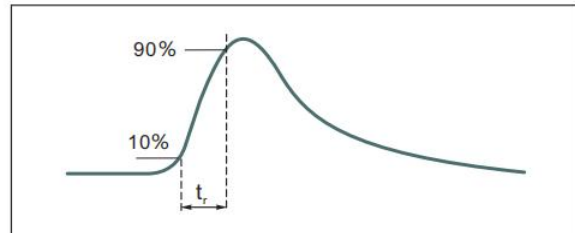

Fig.1: Power dissipation versus ambient temperature(maximum values)

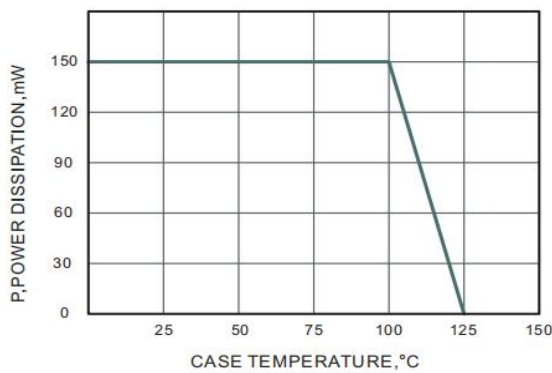

Fig.2: Power dissipation versus ambient temperature(maximum values)

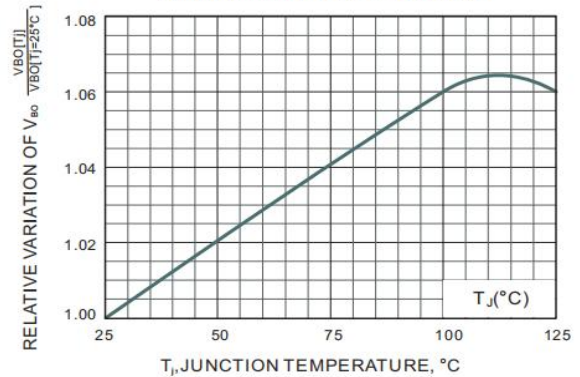
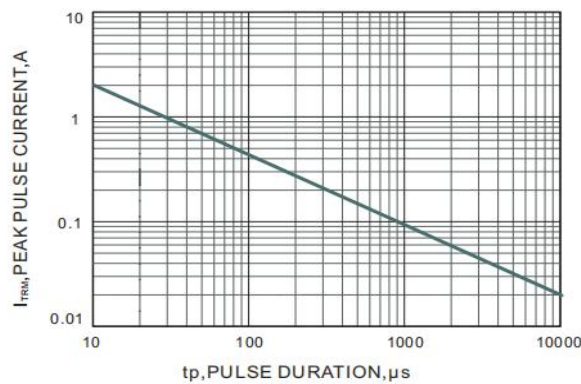
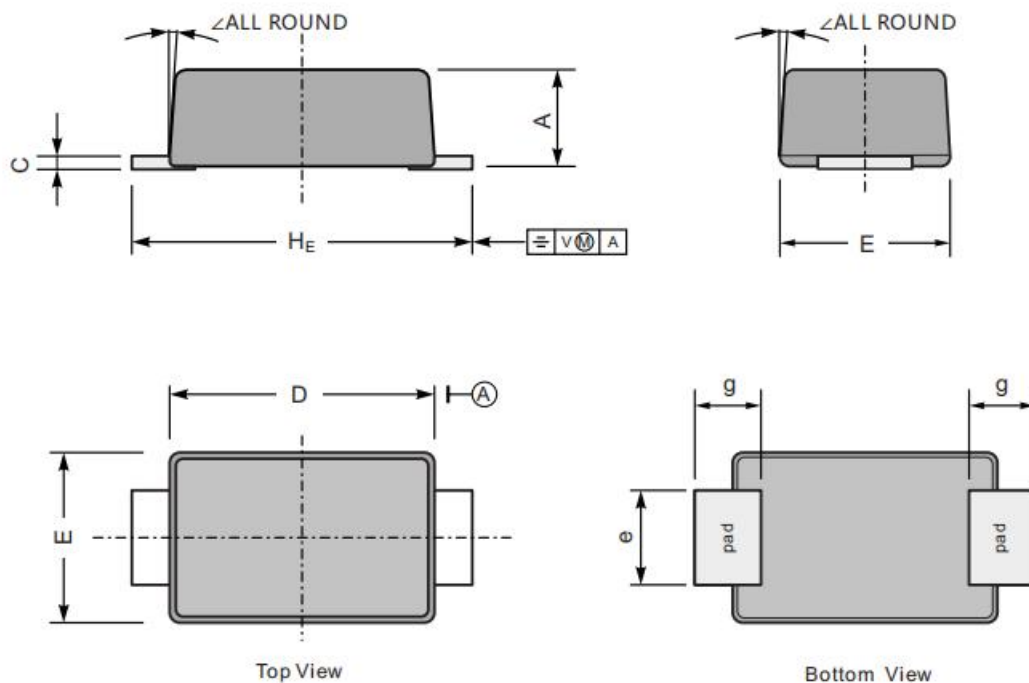

Fig.3: Power dissipation versus ambient temperature(maximum values)



■ Dimension 外形封装尺寸



UNIT		A	C	D	E	e	g	H <sub>E</sub>	∠
mm	max	1.1	0.20	2.9	1.9	1.1	0.9	3.8	7°
	min	0.9	0.12	2.6	1.7	0.8	0.7	3.5	
mil	max	43	7.9	114	75	43	35	150	
	min	35	4.7	102	67	31	28	138	