

REV.	ECR/N NO./DESCRIPTION	DATE	DRAWN	CHECKED	APPROVE
13	SN11229	10/18'11	SKY	Vito.Li	Barney
14	SN15115	10/13'15	Sumer	Vito.Li	Barney
14C	SR****	05/20'16	Mars	Vito.Li	Gear

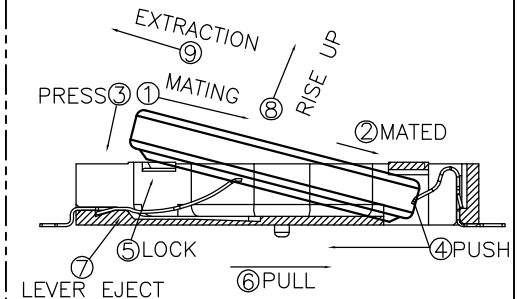
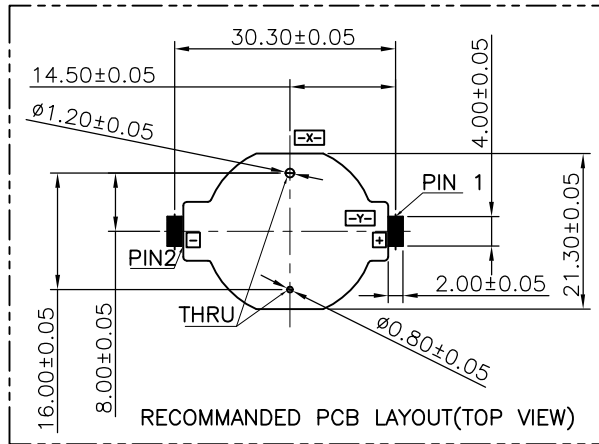
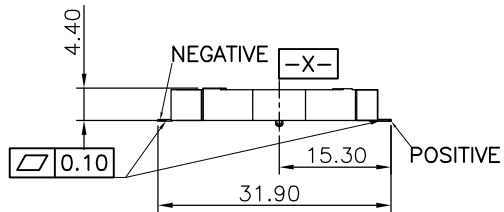
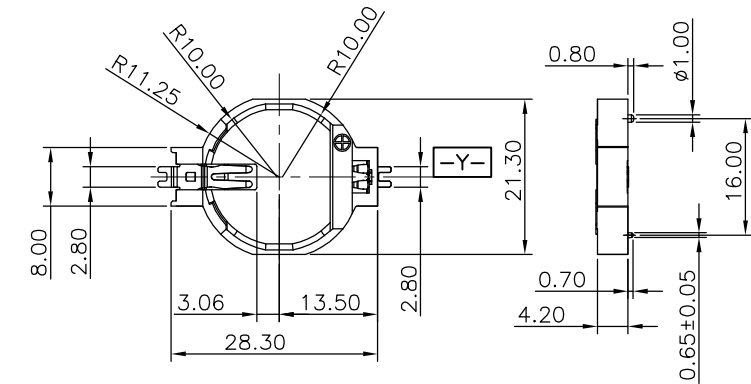

HOW TO MATE AND UNMATE

MATE: ① ——— ⑤
UNMATE: ⑥ ——— ⑨

NOTES:

1.MATERIAL:

1.1 CONTACT: PHOSPHOR BRANZE.

1.2 HOUSING: LCP,UL94V-0,COLOR SEE TABLE.

2.FINISH:

2.1 CONTACT AREA: SEE TABLE.

2.2 SOLDER AREA: SEE TABLE.

3.RoHS COMPLIANT.

HF COMPLIANT.

4.MECHANICAL PERFORMANCE

DURABILITY: 10 CYCLES\INSERTION FORCE: 0.29~1 KGF MAX.

ELECTRICAL PERFORMANCE

LLCR:30 mOHMS MAX\WITHSTANDING VOLTAGE:500 AC FOR 1 MINUTE\

INSULATION RESISTANCE:1000 MOHMS MIN

5.IR REFLOW TEMPERATURE:250°C±10°C FOR 10 SECONDS MAX.

6.PRODUCT NUMBER NOTE

AAA-BAT-***-***

- TYPE SERIAL NUMBER
- K:LEAD FREE/P:HALOGEN FREE
- PRODUCT SERIAL NUMBER
- PRODUCT TYPE
- FINISHED PRODUCT
- WAFER CONTACTOR
- CONTACTOR

GENERAL TOLERANCES UNLESS SPECIFIED		PART NO. SEE TABLE	LOTES			
X ± 0.35	X.° ± 3°					
.XX ± 0.25	.X.° ± 2°	APPROVED BY GEAR	TITLE BATTERY HOLDER 4.2H SMT			
.XXX ± 0.15	.XX.° ± 1°	CHECKED BY KAKA	DWG NO. AP-AAA-BAT-054			
SIZE A4	UNITS MM[INCH]	DRAWN BY Sun		SHEET 1 / 4	SCALE 1 : 1	REV 14C

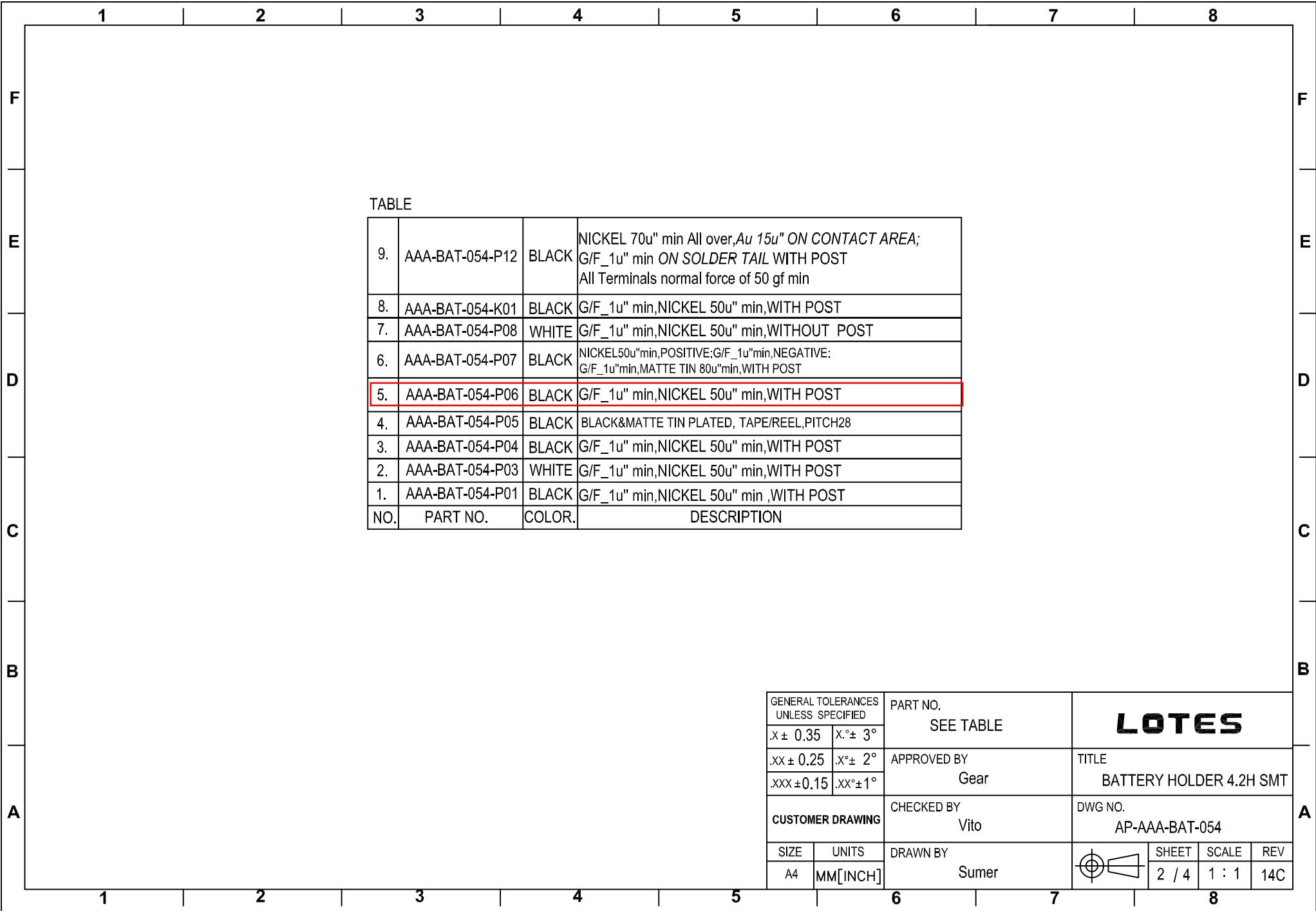

TABLE

9.	AAA-BAT-054-P12	BLACK	NICKEL 70u" min All over,Au 15u" ON CONTACT AREA; G/F_1u" min ON SOLDER TAIL WITH POST All Terminals normal force of 50 gf min
8.	AAA-BAT-054-K01	BLACK	G/F_1u" min,NICKEL 50u" min,WITH POST
7.	AAA-BAT-054-P08	WHITE	G/F_1u" min,NICKEL 50u" min,WITHOUT POST
6.	AAA-BAT-054-P07	BLACK	NICKEL50u"min,POSITIVE:G/F_1u"min,NEGATIVE: G/F_1u"min,MATTE TIN 80u"min,WITH POST
5.	AAA-BAT-054-P06	BLACK	G/F_1u" min,NICKEL 50u" min,WITH POST
4.	AAA-BAT-054-P05	BLACK	BLACK&MATTE TIN PLATED, TAPE/REEL,PITCH28
3.	AAA-BAT-054-P04	BLACK	G/F_1u" min,NICKEL 50u" min,WITH POST
2.	AAA-BAT-054-P03	WHITE	G/F_1u" min,NICKEL 50u" min,WITH POST
1.	AAA-BAT-054-P01	BLACK	G/F_1u" min,NICKEL 50u" min ,WITH POST
NO.	PART NO.	COLOR.	DESCRIPTION

GENERAL TOLERANCES UNLESS SPECIFIED		PART NO. SEE TABLE	LOTES			
X ± 0,35	X.° ± 3°					
XX ± 0,25	.X.° ± 2°	APPROVED BY Gear	TITLE BATTERY HOLDER 4.2H SMT			
.XXX ± 0,15	.XX.° ± 1°	CHECKED BY Vito	DWG NO. AP-AAA-BAT-054			
CUSTOMER DRAWING		DRAWN BY Sumer		SHEET	SCALE	REV
SIZE A4	UNITS MM[INCH]			2 / 4	1 : 1	14C

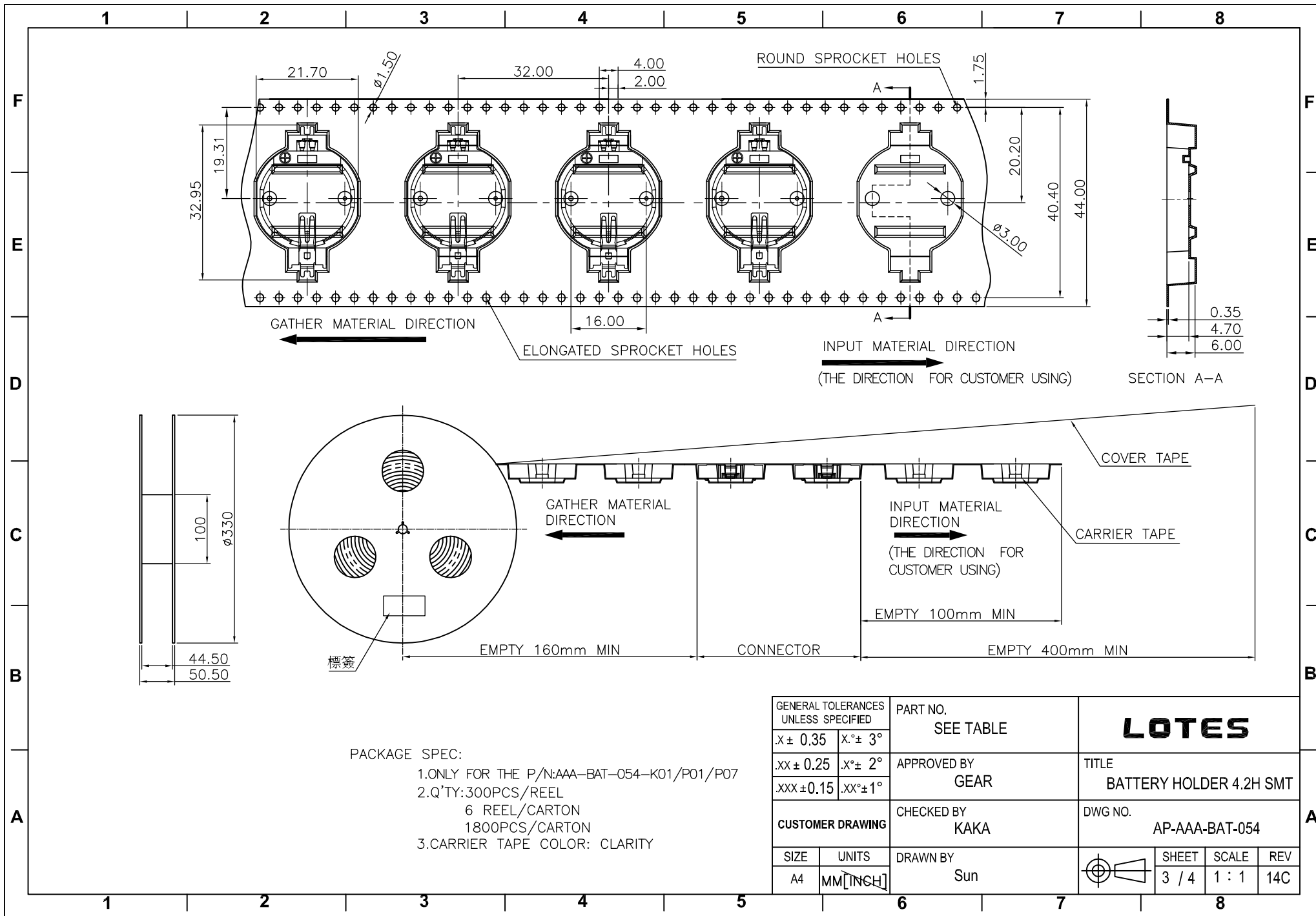

PACKAGE SPEC:
 1. ONLY FOR THE P/N:AAA-BAT-054-K01/P01/P07
 2. Q'TY: 300PCS/REEL
 6 REEL/CARTON
 1800PCS/CARTON
 3. CARRIER TAPE COLOR: CLARITY

GENERAL TOLERANCES UNLESS SPECIFIED		PART NO. SEE TABLE	LOTES			
X ± 0.35	X.° ± 3°					
XX ± 0.25	.X° ± 2°	APPROVED BY GEAR	TITLE BATTERY HOLDER 4.2H SMT			
.XXX ± 0.15	.XX° ± 1°	CHECKED BY KAKA	DWG NO. AP-AAA-BAT-054			
CUSTOMER DRAWING		DRAWN BY Sun		SHEET 3 / 4	SCALE 1 : 1	REV 14C
SIZE A4	UNITS MM [INCH]					

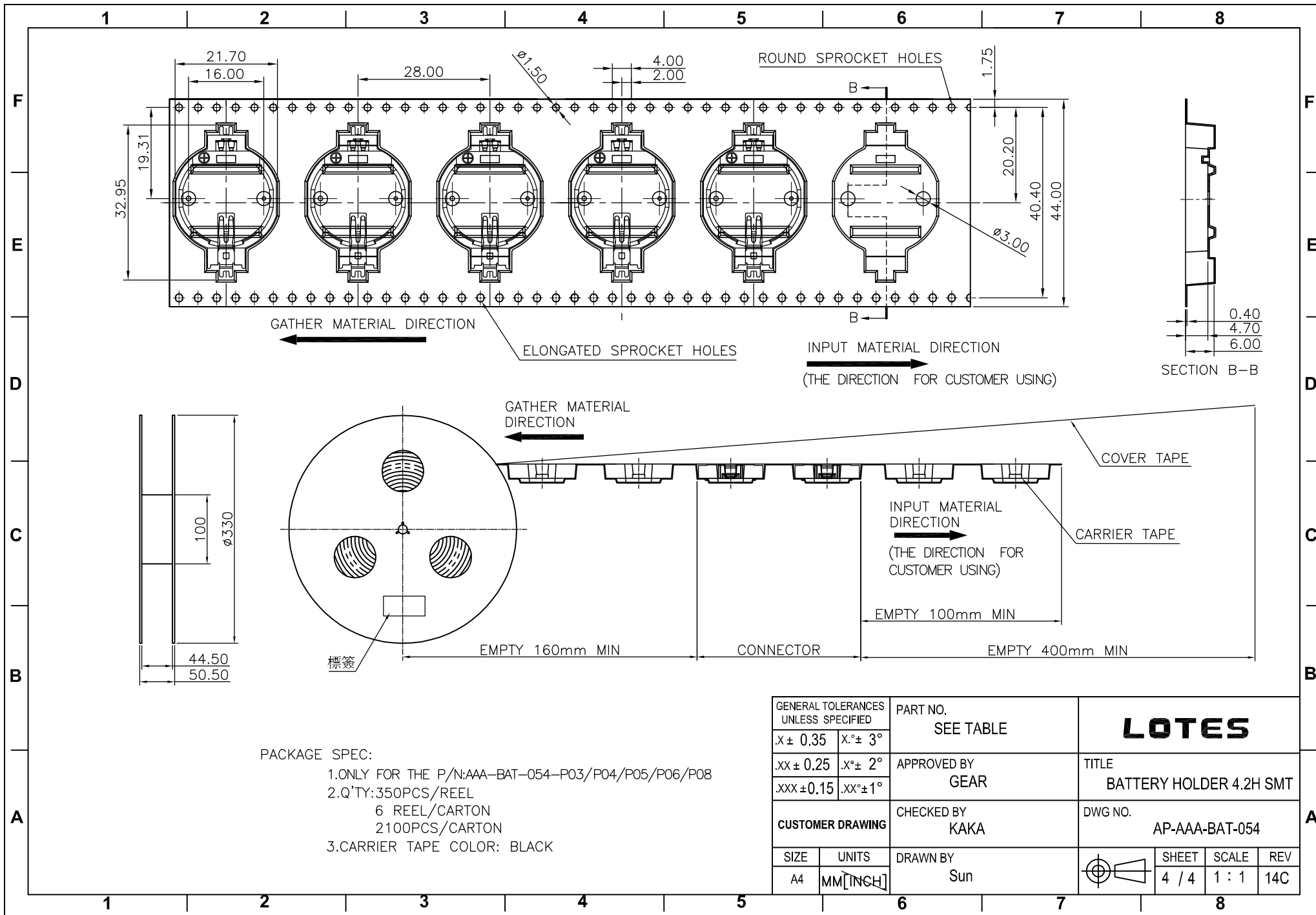

PACKAGE SPEC:
 1. ONLY FOR THE P/N: AAA-BAT-054-P03/P04/P05/P06/P08
 2. Q'TY: 350PCS/REEL
 6 REEL/CARTON
 2100PCS/CARTON
 3. CARRIER TAPE COLOR: BLACK

GENERAL TOLERANCES UNLESS SPECIFIED		PART NO. SEE TABLE	LOTES		
X ± 0.35	X.° ± 3°				
XX ± 0.25	.X.° ± 2°	APPROVED BY GEAR	TITLE BATTERY HOLDER 4.2H SMT		
.XXX ± 0.15	.XX.° ± 1°	CHECKED BY KAKA	DWG NO. AP-AAA-BAT-054		
CUSTOMER DRAWING		DRAWN BY Sun	SHEET 4 / 4	SCALE 1 : 1	REV 14C
SIZE A4	UNITS MM [INCH]				