

# AT53AL SERIES

## 40V Ultralow-Quiescent-Current LDO

Input Voltage: up to 40V Output: 2.5-5.0V

### General Description

The AT53AL Series ultra-low quiescent current regulator features low dropout voltage and low current in the standby mode. With less than 1.5 $\mu$ A quiescent current at no load, the AT53AL Series is ideally suited for standby micro-control-unit systems, especially for always-on applications like E-meters, fire alarms, smoke detectors and other battery operated systems. The AT53AL Series retains all of the features that are common to low dropout regulators including a low dropout PMOS pass device, short circuit protection, and thermal shutdown.

The AT53AL Series has a 40V maximum operating voltage limit, -40°C to 125°C operating temperature range, and  $\pm$ 2% output voltage tolerance over the entire output current, input voltage, and temperature range. The AT53AL Series is available in SOT23-5 and SOT-89 surface mount packages.

### Features

- ◆ Vin Voltage Range up to 40V
- ◆ Output Voltage Tolerances of  $\pm$ 2%
- ◆ Maximum Output Current of 150mA
- ◆ Ultra Low Quiescent Current
- ◆ Dropout Voltage Typically 1200 mV at  $I_{OUT} = 150$  mA
- ◆ Internal Thermal Overload Protection
- ◆ Internal Short-Circuit Current Limit
- ◆ Ceramic Capacitor Stable

### Applications

- ◆ E-meters, Water Meters and Gas Meters
- ◆ Fire Alarm, Smoke Detector
- ◆ Appliances and White Goods

### Pin Configuration

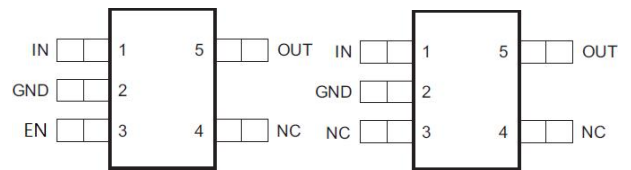

AT53ALXXESE  
SOT23-5

AT53ALXXSE  
SOT23-5

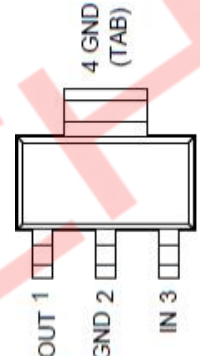
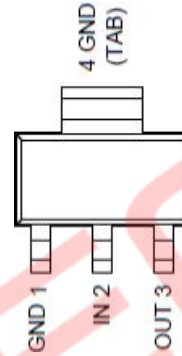

AT53ALXXSQB  
SOT-89

AT53ALXXSQ  
SOT-89

### Typical Application Circuit

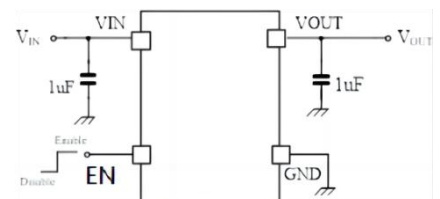
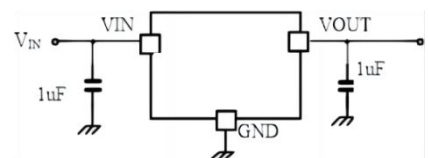

# AT53AL SERIES

## Pin Assignment

Pin Name	SOT23-5		SOT-89		Pin Function
	AT53ALXXESE	AT53ALXXSE	AT53ALXXSQB	AT53ALXXSQ	
V <sub>OUT</sub>	5	5	3	1	Output Voltage Pin
GND	2	2	1	2,4	Ground
V <sub>IN</sub>	1	1	2,4	3	Input Voltage Pin
EN	3	---	---	---	Enable
CN	4	3,4	---	---	/

## Function Block Diagram

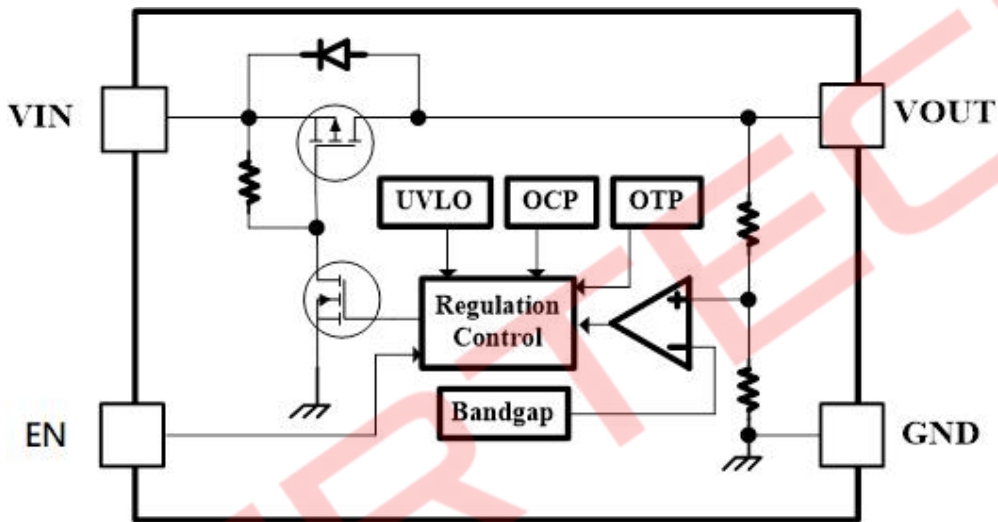

## Selection Guide

**AT 53AL XX XX**

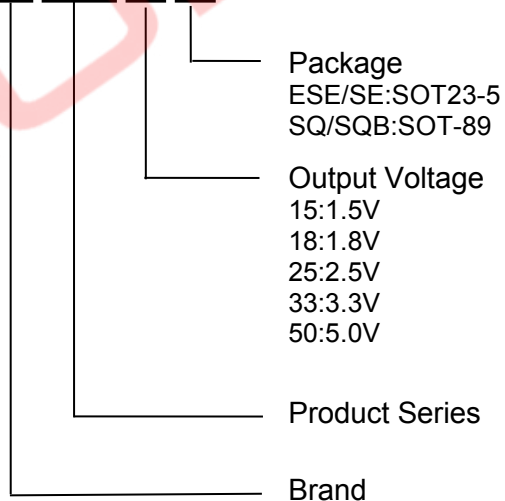

# AT53AL SERIES

## Electrical Characteristics (Ratings at 25°C ambient temperature unless otherwise specified)

Parameter		Value	Unit
V <sub>OUT</sub> to GND Voltage		-0.3~7	V
V <sub>IN</sub> to GND Voltage		-0.3~45	V
EN Pin to GND Voltage		-0.3~45	V
Power Dissipation	SOT-89	0.5	W
	SOT23-5	0.4	
Thermal Resistance, Junction-to-Ambient	SOT-89	200	°C/W
	SOT23-5	250	
Operating temperature range		-40~125	°C

## Electrical Characteristics (V<sub>IN</sub>=12V, I<sub>OUT</sub>=1mA, C<sub>IN</sub>=C<sub>OUT</sub>=1uF, T<sub>J</sub>=25°C, unless otherwise specified)

Parameter	Symbol	Test Conditions	Min	Typ	Max	Units
Output Voltage Range	V <sub>OUT</sub>		1.5		5.5	V
Output Voltage Accuracy	ΔV <sub>OUT</sub>		-2		2	%
Line Regulation	ΔV <sub>LINE</sub>	V <sub>IN</sub> = V <sub>OUT</sub> + 1V to 40V, or V <sub>IN</sub> = 5V to 40V, if V <sub>OUT</sub> < 4V			12	mV
Load Regulation	ΔV <sub>LOAD</sub>	I <sub>OUT</sub> = 1mA to 100mA			30	mV
		I <sub>OUT</sub> = 1mA to 150mA			80	
Dropout Voltage	V <sub>DROP</sub>	I <sub>OUT</sub> = 100mA		400		mV
		I <sub>OUT</sub> = 150mA		1200		mV
Quiescent Current	I <sub>Q</sub>	T <sub>J</sub> = 25°C			4	uA
Current Limit	I <sub>CL</sub>		270	340		mA
Enable high level	V <sub>ENHI</sub>		0.9			V
Enable low level	V <sub>ENLO</sub>				0.4	V
Enable pin pull high current	I <sub>EN</sub>			0.1		uA
Thermal Shutdown	T <sub>SD</sub>			140		°C
Thermal Shutdown Hysteresis	T <sub>HY</sub>			20		°C
Power-supply rejection ratio	PSRR	f = 1kHz		80		dB
		f = 10kHz		60		dB
Human body model	HBM		3			KV
Charged device model	CDM		200			V

# AT53AL SERIES

**Typical Characteristics** ( $V_{IN}=12V$ ,  $I_{OUT}=1mA$ ,  $V_{OUT}=3.3V$ ,  $C_{IN}=C_{OUT}=1\mu F$ ,  $T_J=25^\circ C$ , unless otherwise specified)

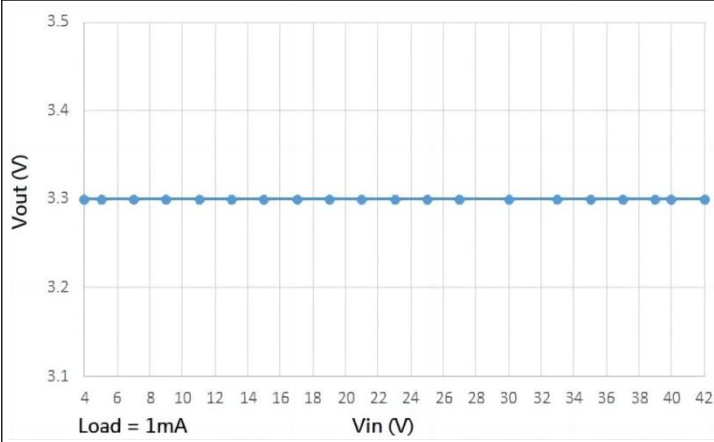

Fig 1 Vout vs Vin

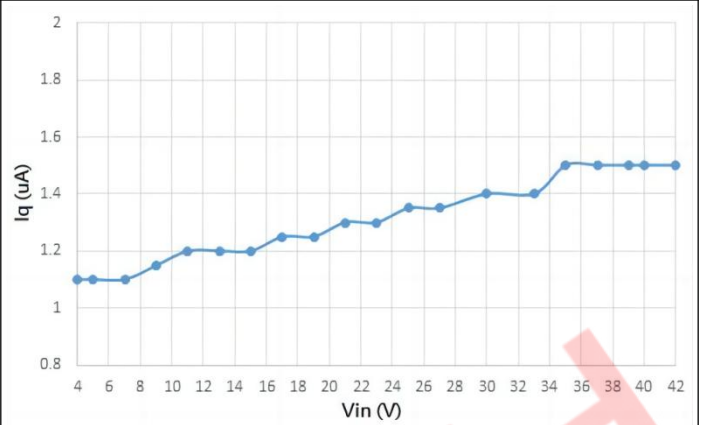

Fig 2 Iq vs Vin

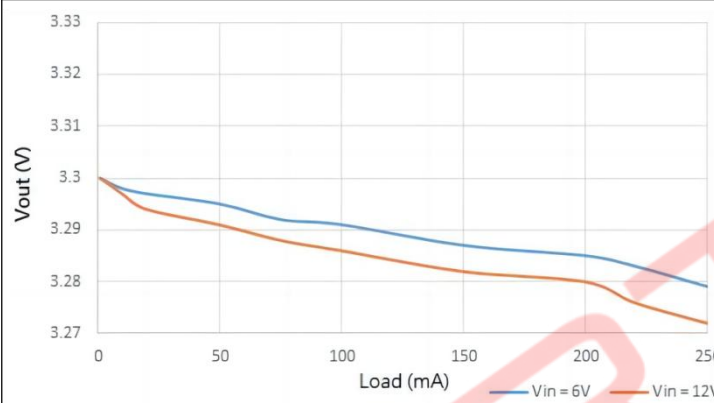

Fig 3 Vout vs Load

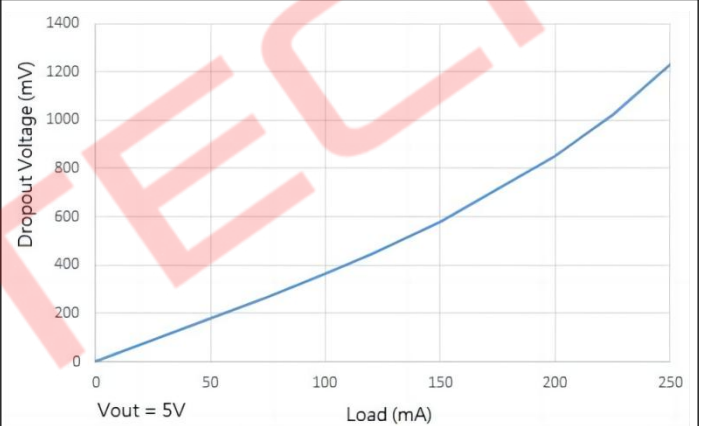

Fig 4 Dropout vs Load

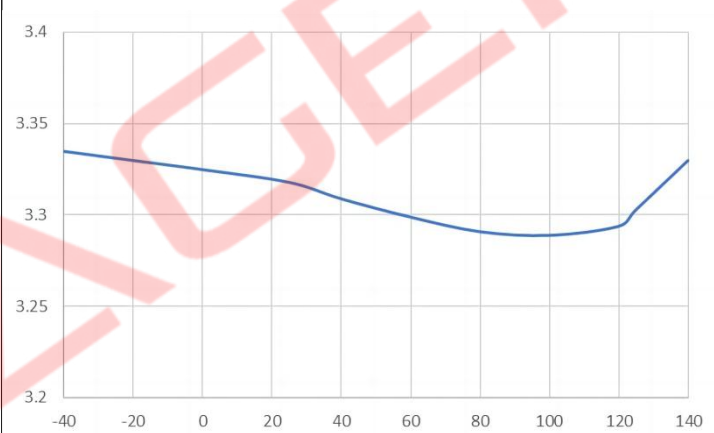

Fig 5 Vout(3.3V) vs Temperature

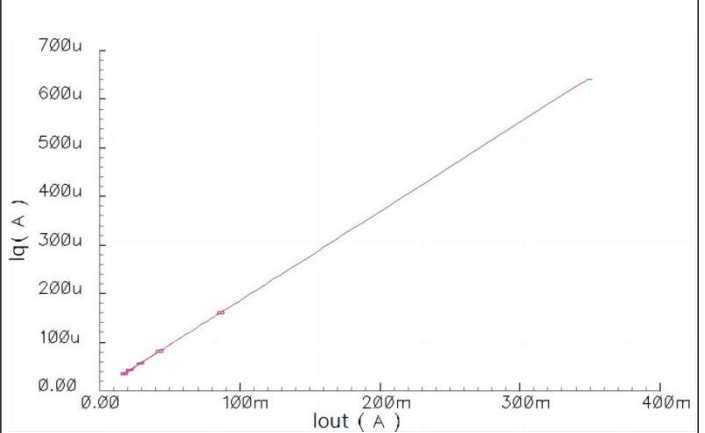

Fig 6 Iq vs Load

# AT53AL SERIES

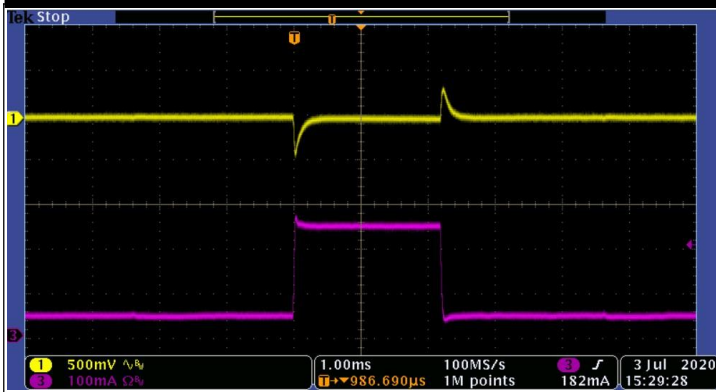

Fig 7 Vout Load transient(50 to 250mA)

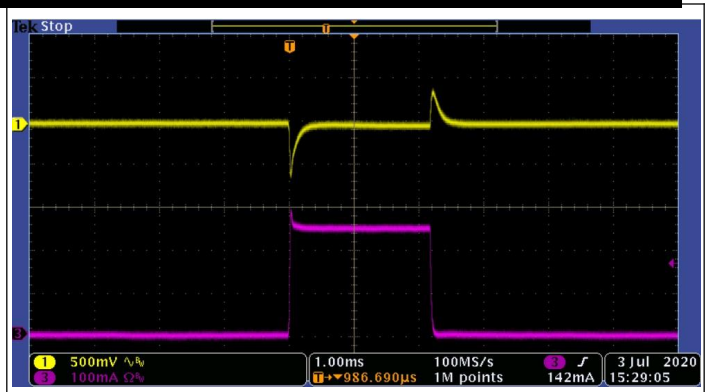

Fig 8 Vout Load Transient(1 to 250mA)

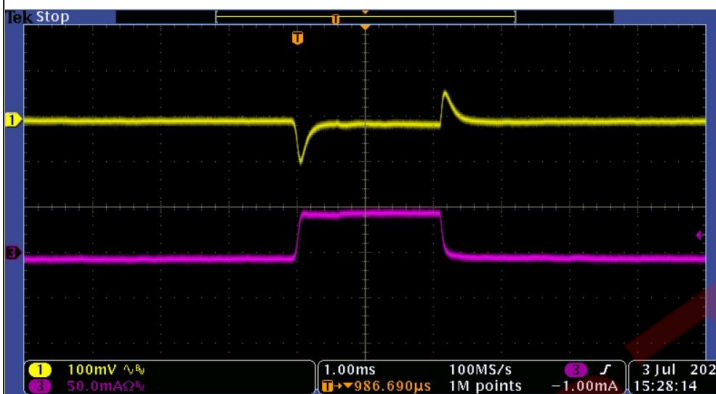

Fig 9 Vout Load Transient(0 to 50mA)

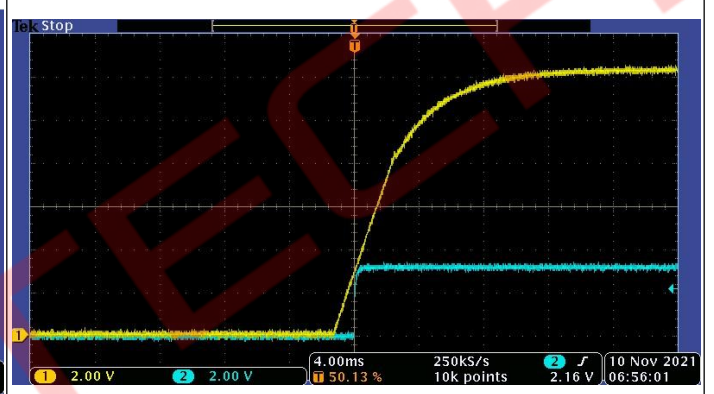

Fig 10 Vin Start up

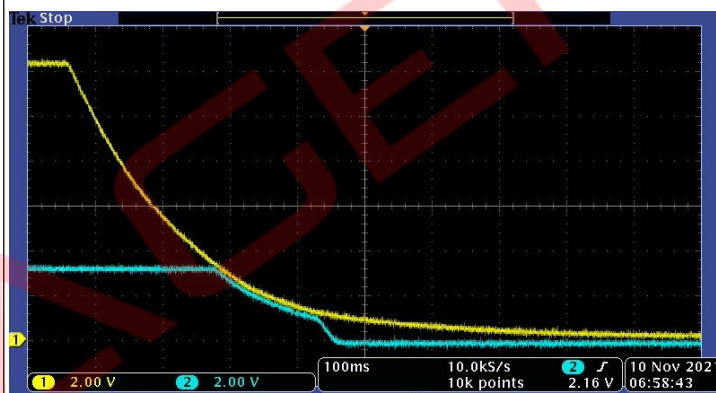

Fig 11 Vin power off

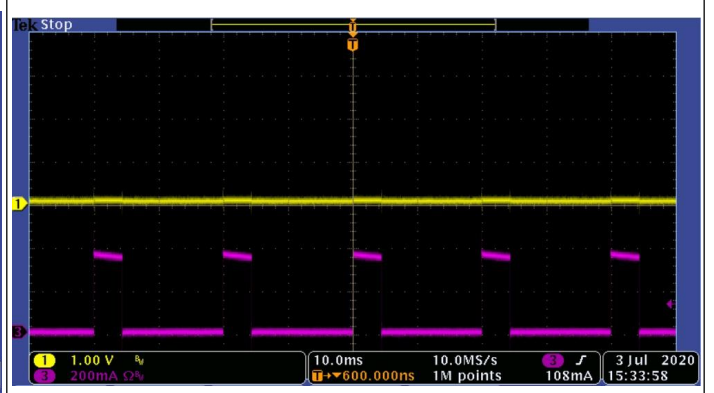
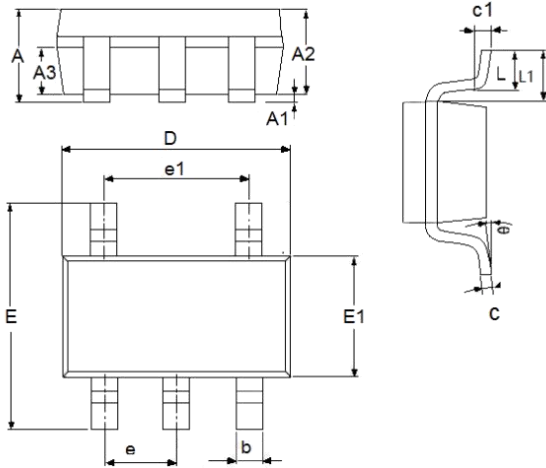

Fig 12 Vout Short to GND

# AT53AL SERIES

## PACKAGE OUTLINE

### SOT23-5



DIM	Millimeters		Inches	
	Min	Max	Min	Max
A	1.05	1.45	0.0413	0.0571
A1	0	0.15	0.0000	0.0059
A2	0.9	1.3	0.0354	0.0512
A3	0.6	0.7	0.0236	0.0276
b	0.25	0.5	0.0098	0.0197
c	0.1	0.23	0.0039	0.0091
D	2.82	3.05	0.1110	0.1201
e1	1.9(TYP)		0.0748(TYP)	
E	2.6	3.05	0.1024	0.1201
E1	1.5	1.75	0.0512	0.0689
e	0.95(TYP)		0.0374(TYP)	
L	0.3	0.6	0.0118	0.0236
L1	0.59(TYP)		0.0232(TYP)	
θ	0	8°	0.0000	8°
C1	0.2(TYP)		0.0079(TYP)	

### SOT-89

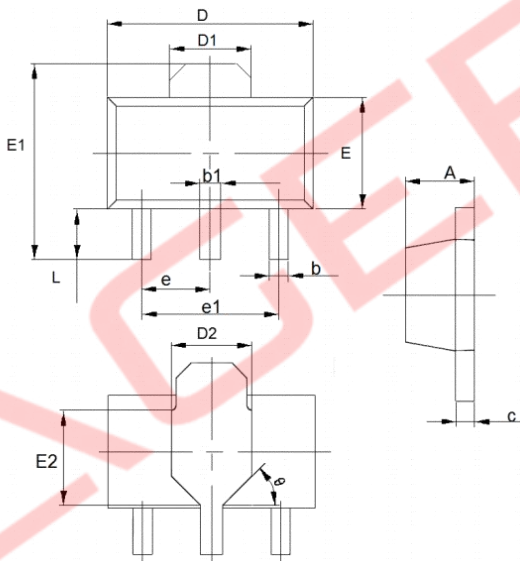

DIM	Millimeters		Inches	
	Min	Max	Min	Max
A	1.4	1.6	0.0551	0.0630
b	0.32	0.52	0.0126	0.0205
b1	0.4	0.58	0.0157	0.0228
c	0.35	0.45	0.0138	0.0177
D	4.4	4.6	0.1732	0.1811
D1	1.55(TYP)		0.061(TYP)	
D2	1.75(TYP)		0.0689(TYP)	
e1	3.0(TYP)		0.1181(TYP)	
E	2.3	2.6	0.0906	0.1023
E1	3.94	4.4	0.1551	0.1732
E2	1.9(TYP)		0.0748(TYP)	
e	1.5(TYP)		0.0591(TYP)	
L	0.8	1.2	0.0315	0.0472
θ	45°		45°	