



Specification for Approval

- DEVICE NUMBER: BIR-BM13E4G-2
- CUSTOMER:

SAMPLES
ATTACHED AREA

DATE \ PAGE	1	2	3	4	5						CONTENTS	
2017/3/2	1.0	1.0	1.0	1.0	1.0							Initial Released

FOR CUSTOMER'S APPROVAL STAMP OR SIGNATURE

APPROVED	PURCHASE	MANUFACTURE	QUALITY	ENGINEERING

佰鴻工業股份有限公司
 BRIGHT LED ELECTRONICS CORP.
 新北市板橋區和平路 19 號 3 樓
 3F., No.19, He Ping Road,
 Ban Qiao Dist., New Taipei City,
 Taiwan
 Tel: +886-2-29591090
 Fax: +886-2-29547006/29558809
www.brtled.com

ISSUED	APPROVED	PREPARED

END-LOOK PACKAGE LIGHT EMITTING DIODE

I Features:

1. High radiant power and high radiant intensity.
2. Standard T-1 3/4(5mm)package.
3. Peak wavelength $\lambda_p=940\text{nm}$.
4. Good spectral matching to si-photodetector.
5. Radiant angle: 40°
6. Lens Appearance: Water Clear.
7. This product doesn't contain restriction substance, comply RoHS standard

I Applications:

1. Remote Control.
2. Automatic Control System.

I Package Dimensions:

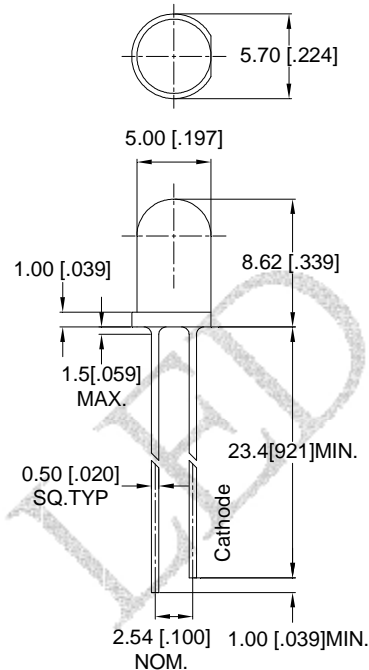

NOTES:

1. All dimensions are in millimeters (inches).
2. Tolerance is $\pm 0.25\text{mm}$ (0.01") unless otherwise specified.
3. Lead spacing is measured where the leads emerge from the package.
4. Specifications are subject to change without notice.

I Absolute Maximum Ratings($T_a=25^\circ\text{C}$)

Parameter	Symbol	Rating	Unit
Power Dissipation	P_d	150	mW
Continuous Forward Current	I_F	100	mA
Peak Forward Current ^{*1}	I_{FP}	1.0	A
Reverse Voltage	V_R	5	V
Operating Temperature	T_{opr}	$-40^\circ\text{C} \sim 85^\circ\text{C}$	-
Storage Temperature	T_{stg}	$-45^\circ\text{C} \sim 85^\circ\text{C}$	-

^{*1} (300pps 10us pulse)

I Optical- Electrical Characteristics (Ta=25°C)

Parameter	Symbol	Test Conditions	Min	TYP	Max	Unit
Radiant Intensity	I _e	I _F =50mA	9.90	30	-	mW/sr
Forward Voltage	V _F	I _F =50mA	-	1.25	1.5	V
Reverse Current	I _R	V _R =5V	-	-	100	μA
Peak Wavelength	λ _p	I _F =50mA	-	940	-	nm
Spectral Line Half- Width	Δλ	I _F =50mA	-	50	-	nm
Viewing Angle	2θ _{1/2}	I _F =20mA	-	40	-	deg

I Typical Optical-Electrical Characteristic Curves

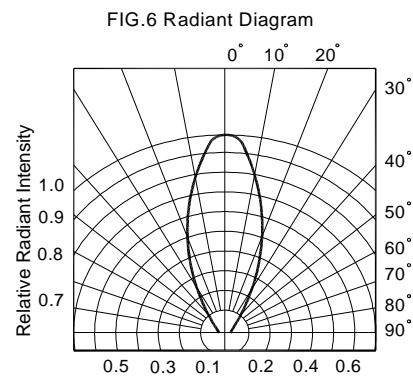
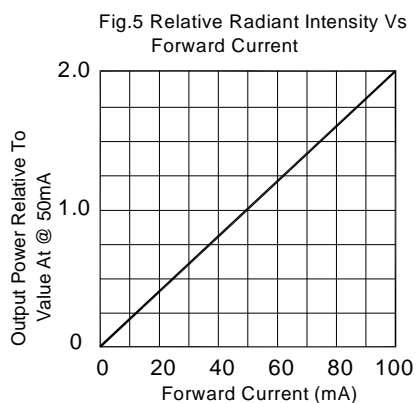
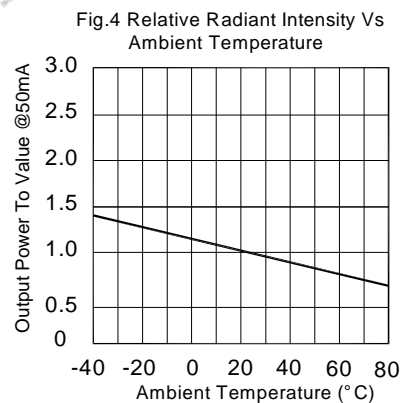
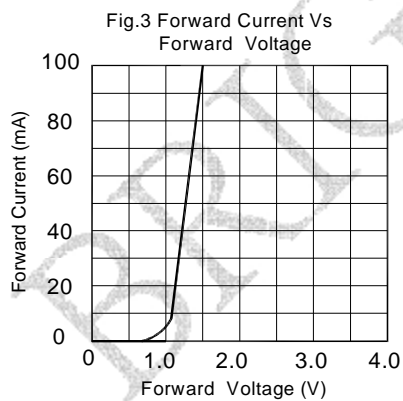
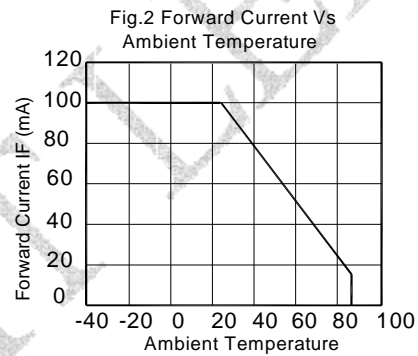
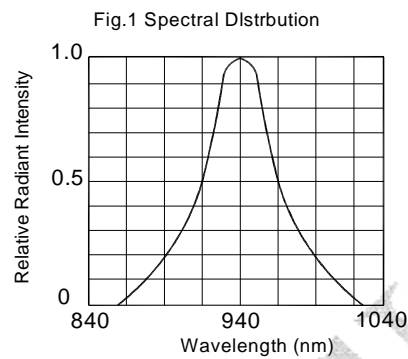

● Dip Soldering

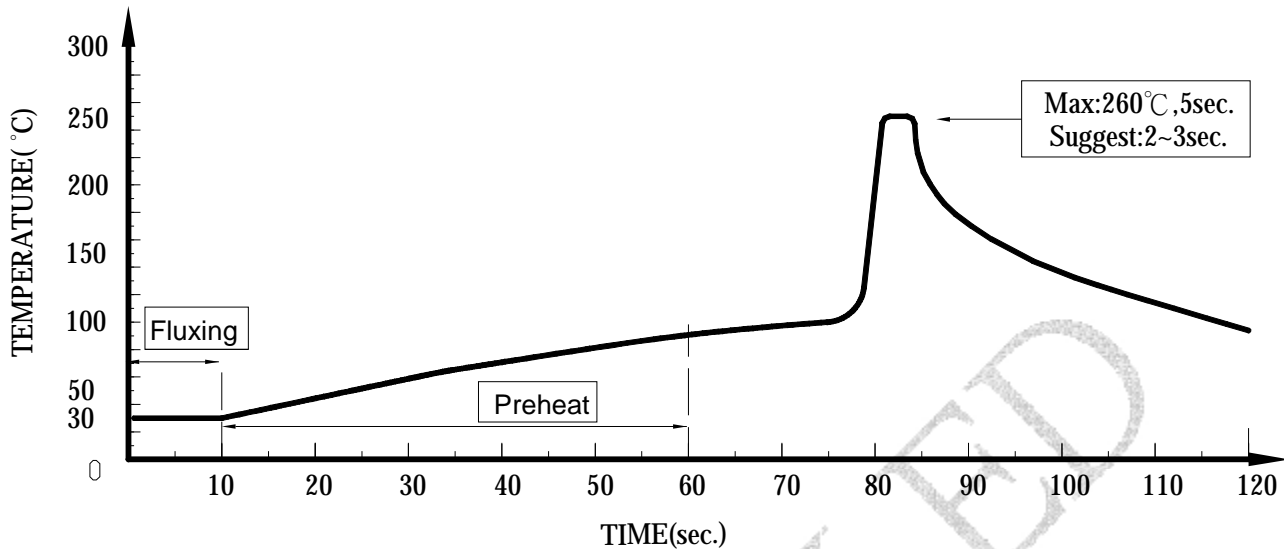

1. Please avoid any external stress applied to the lead-frames and epoxy while the LEDs are at high temperature, especially during soldering
2. DIP soldering and hand soldering should not be done more than one time.
3. After soldering, avoid the epoxy lens from mechanical shock or vibration until the LEDs are back to room temperature.
4. Avoid rapid cooling during temperature ramp-down process
5. Although the soldering condition is recommended above, soldering at the lowest possible temperature is feasible for the LEDs

● IRON Soldering

A: Max: 350°C Within 3 sec. One time only.

B: The products of 3mm without flange, welding condition of flat plate PCB Max: 350°C Within 2 sec. One time only

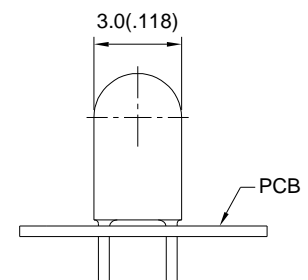

I Tapping and packaging specifications(Units: mm)

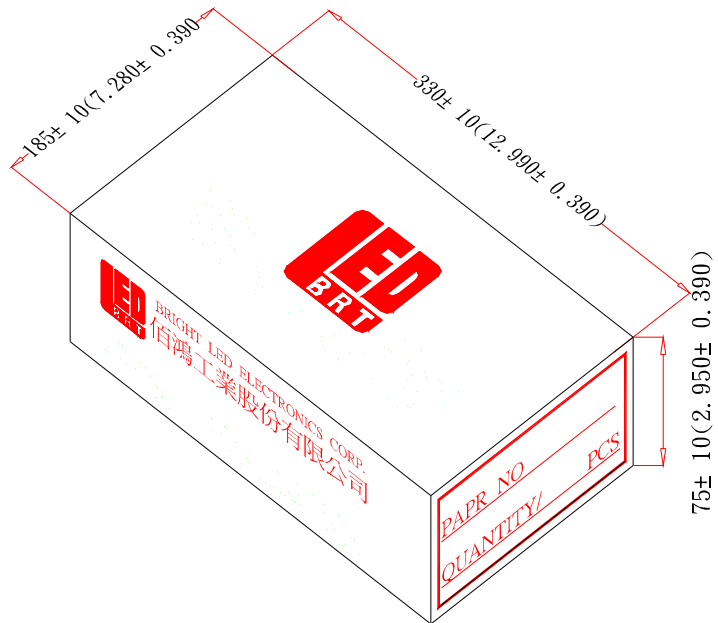

I Packaging Bag Dimensions

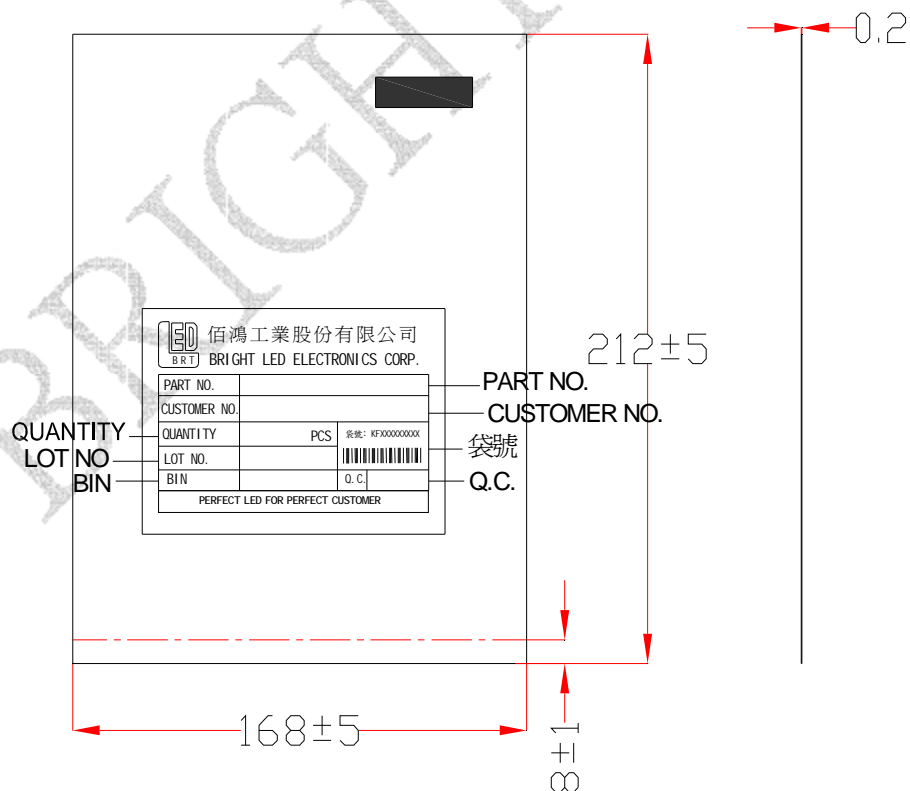

Notes:

- 1、500pcs per bag, 5Kpcs per box.
- 2、All dimensions are in millimeters(inches).
- 3、Specifications are subject to change without notice.



Infrared Emitting Diode Specification

2Commodity: Infrared emitting diode

2Intensity Bin Limits (At 50mA)

BIN CODE	Min.(mW/sr)	Max.(mW/sr)
11	9.90	13.81
12	13.81	19.42
13	19.42	27.20
14	27.20	38.08
15	38.08	53.31
16	53.31	74.63

NOTES: Tolerance of measurement of Radiant Intensity :±15%