

## Features

- Low gate charge
- Trench FS Technology,
- saturation voltage:  $V_{CE(sat)}$ , type =1.6V,  $I_C=50A$  and  $T_C =25^\circ C$
- RoHS product

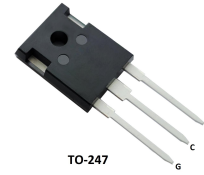

## Applications

- General purpose inverters
- UPS

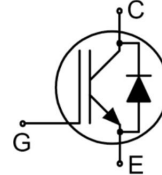

## Absolute Ratings ( $T_C=25^\circ C$ )

Parameter	Symbol	Value	Unit
Collector-Emmitter Voltage	$V_{ces}$	650	V
*Collector Current-continuous	$I_C$ $T=25^\circ C$ $T=100^\circ C$	100	A
		50	A
Collector Current-pulse(note 1)	$I_{CM}$	200	A
Diode RMS forward current	$I_F$ $T=25^\circ C$ $T=100^\circ C$	50	A
		25	A
Gate-Emmitter Voltage	$V_{GES}$	$\pm 30$	V
Power Dissipation	$P_D$ $T_C=25^\circ C$	368	W
Operating Temperature Range	$T_J$	-55~175	$^\circ C$
Storage Temperature Range	$T_{STG}$	-55~+175	$^\circ C$
Maximum Lead Temperature for Soldering Purposes	$T_L$	300	$^\circ C$

\*Collector current limited by maximum Junction temperature

## Thermal Characteristic

Parameter	Symbol	Tests conditions	Min	Typ	Max	Units
Off-Characteristics						
Collector-Emmitter Voltage	$BV_{CES}$	$I_C=250\mu A, V_{GE}=0V$	650	-	-	V
Breakdown Voltage Temperature Coefficient	$\Delta BV_{CES}/\Delta T_J$	$I_C=0.5mA$ , referenced to $25^\circ C$	-	0.6	-	V/ $^\circ C$
Zero Gate Voltage Collector Current	$I_{CES}$	$V_{CE}=650V, V_{GE}=0V, T_C=25^\circ C$	-	-	0.2	mA

Gate-body leakage current	$I_{GES}$	$V_{CE}=0V, V_{GE}=\pm 30V$	-	-	$\pm 200$	nA
<b>On-Characteristics</b>						
Gate-Emmitter Threshold Voltage	$V_{GE(th)}$	$V_{CE}=V_{GE}, I_c=250\mu A$	4.0	-	6.5	V
Collector-Emmitter saturation Voltage	$V_{CESAT}$	$V_{GE}=15V, I_c=50A, T_c=25^\circ C$	-	1.6	2.2	V
<b>Dynamic Characteristics</b>						
Input capacitance	$C_{ies}$	$V_{CE}=25V, V_{GE}=0V, f=1.0MHz, T_c=25^\circ C$	-	3330	-	pF
Output capacitance	$C_{oes}$		-	270	-	pF
Reverse transfer capacitance	$C_{res}$		-	78	-	pF
Total Gate Charge	$Q_g$	$V_{CC}=520V, I_c=50A, V_{GE}=15V, T_c=25^\circ C$	-	118	-	nC
Gate to emitter charge	$Q_{ge}$		-	33	-	
Gate to collector charge	$Q_{gc}$		-	48	-	
Short current	$I_{sc}$	$V_{GE}=15V, V_{CE}=300V, T_{Jstart} \leq 150^\circ C, t \leq 10\mu s$	-	295	-	A
<b>Switching Characteristics</b>						
Turn-On delay time	$t_{d(on)}$	$V_{CC}=400V, I_c=50A, R_G=10\Omega, V_{GE}=15V, T_c=25^\circ C$	-	33	-	ns
Turn-On rise time	$t_r$		-	105	-	ns
Turn-off delay time	$t_{d(off)}$		-	140	-	ns
Turn-off Fall time	$t_f$		-	72	-	ns
Turn-on energy	$E_{on}$		-	0.65	-	mJ
Turn-off energy	$E_{off}$		-	1.53	-	mJ
Total switching Energy	$E_{tot}$		-	2.20	-	mJ
<b>Anti-Paraller Diode Characteristics and Maximum Ratings</b>						
Diode Forward Voltage	$V_F$	$V_{GE}=0V, I_F=20A.$	-	1.7	2.4	V
Diode Reverse recovery time	$t_{rr}$	$V_{GE}=0V, V_R=400V, I_F=50A, di/dt=200A/us$	-	25	-	ns
Reverse recovery charge	$Q_{rr}$		-	15	-	$\mu C$
Diode Reverse recovery Current	$I_{rrm}$		-	1.2	-	A

**Electrical Characteristics**

<b>Parameter</b>	<b>Symbol</b>	<b>Value</b>	<b>Unit</b>
Thermal Resistance, Junction to Case	$R_{th(j-c)}$	0.34	$^{\circ}C/W$
Thermal Resistance, Junction to Ambient	$R_{th(j-A)}$	34	$^{\circ}C/W$

## Notes:

- 1: Pulse width limited by maximum junction temperature
- 2: Pulse Test: Pulse Width  $\leq 300\mu s$ , Duty Cycle  $\leq 2\%$
- 3: Essentially independent of operating temperature

### Electrical Characteristics (curves)

Output Characteristics (25°C)

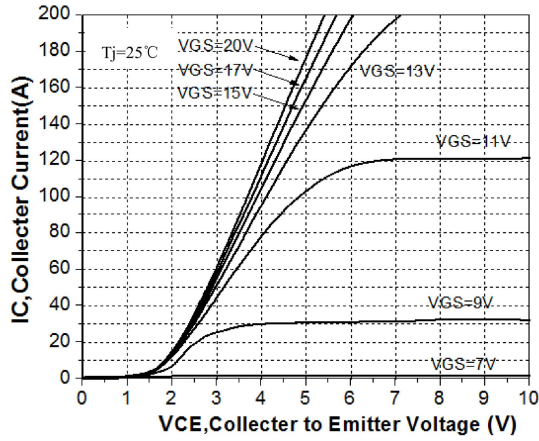

Output Characteristics (175°C)

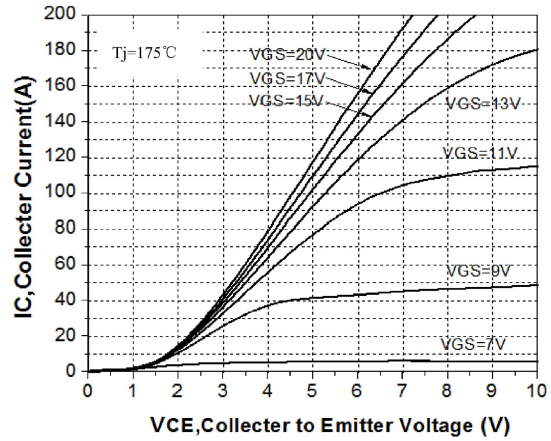

Transfer Characteristics

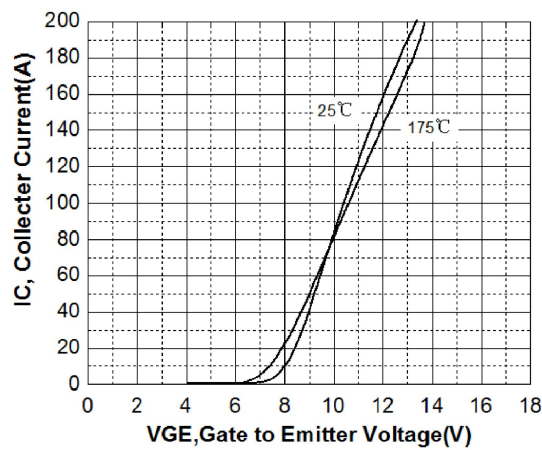

Vcesat vs. Tj

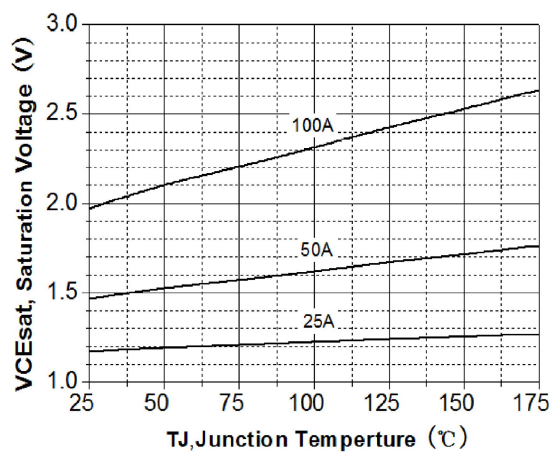

VF vs. Tj

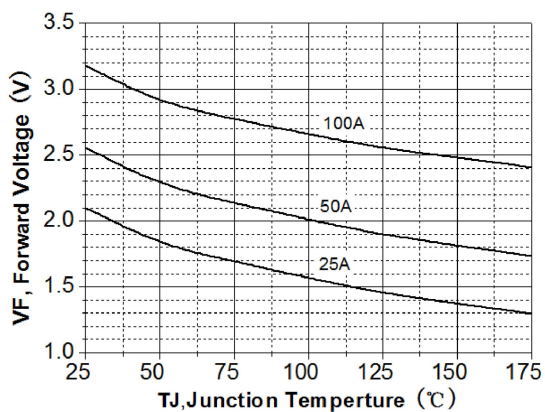

Vth vs. Tj

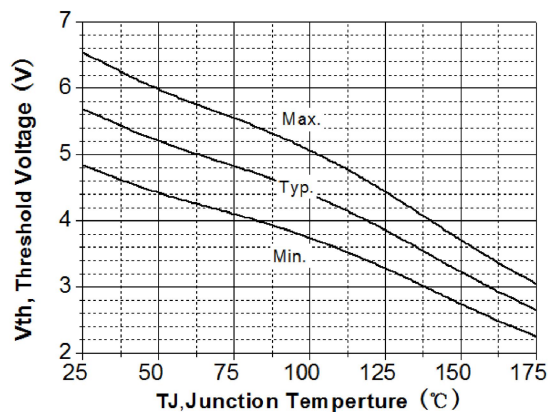

### Diode Characteristic

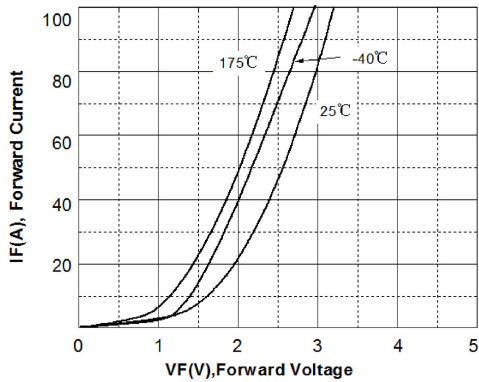

### Collector current vs. case temperature

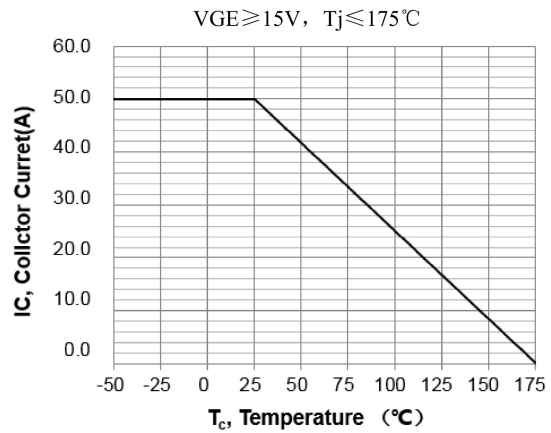

### Gate Charge Characteristics

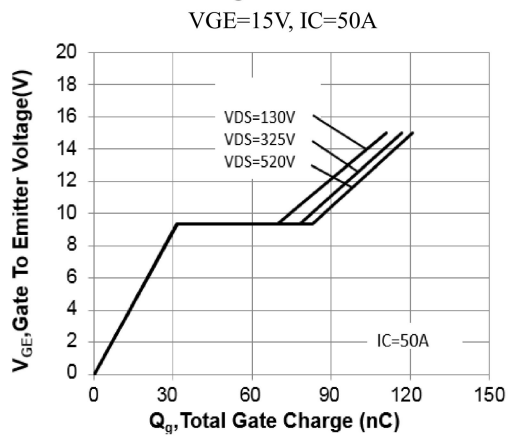

### Capacitance Characteristic

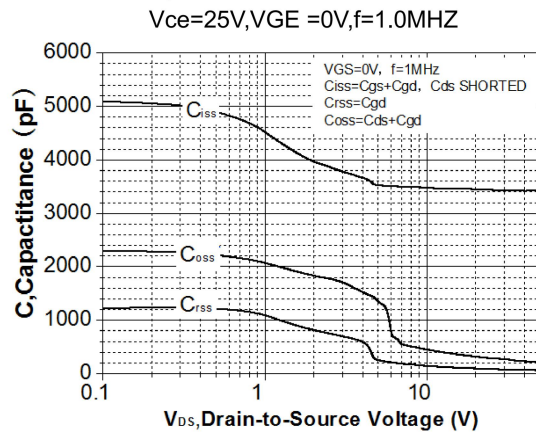

### Switching Time vs. IC(25°C)

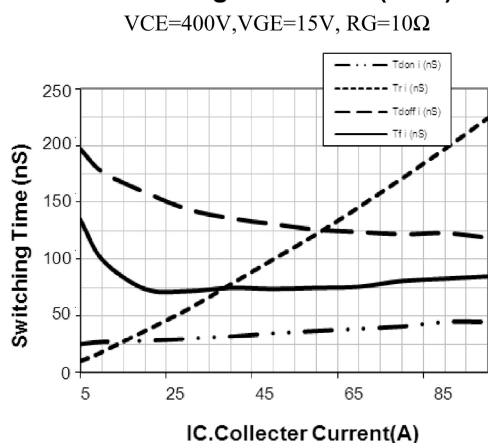

### Switching Time vs. IC(175°C)

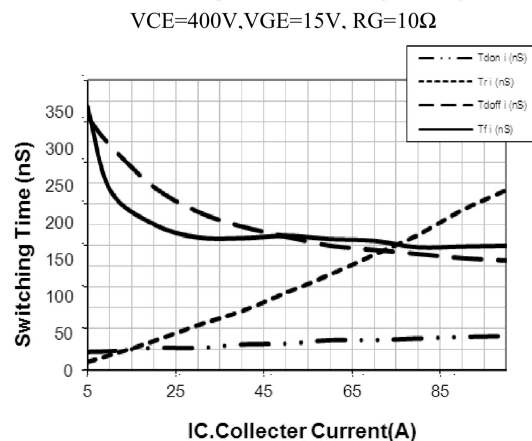

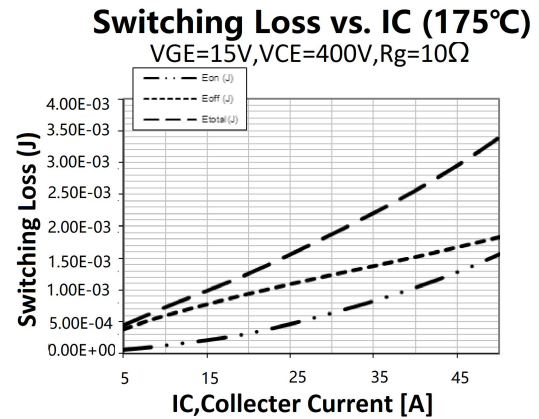
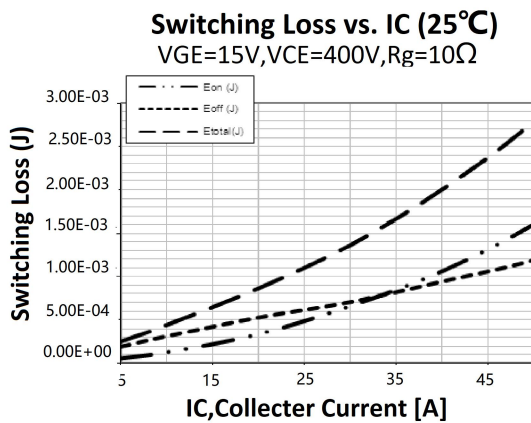
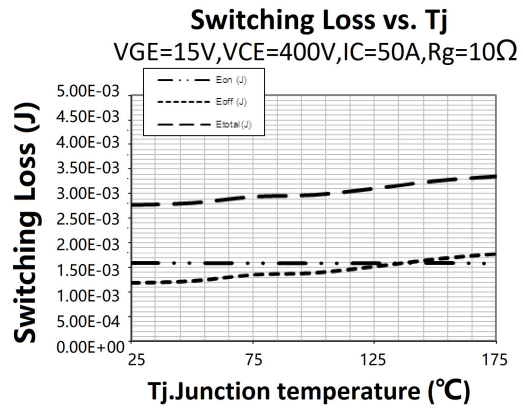
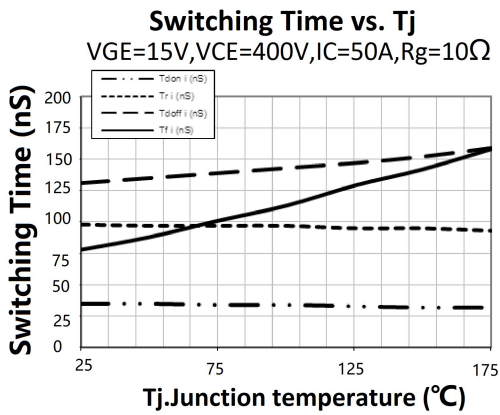
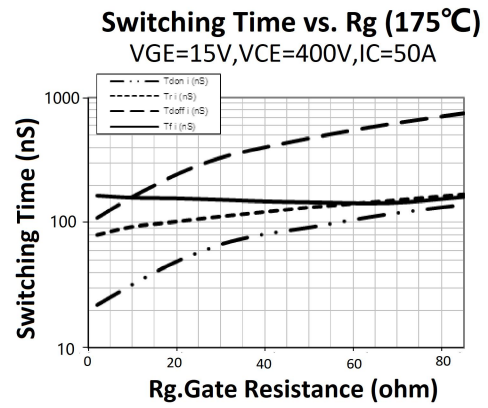
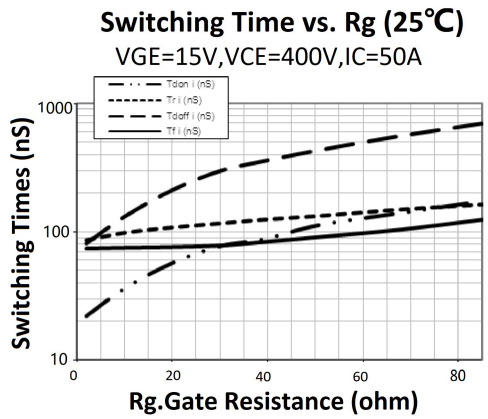

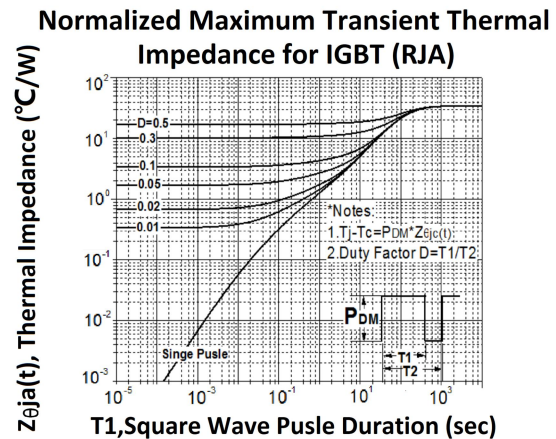
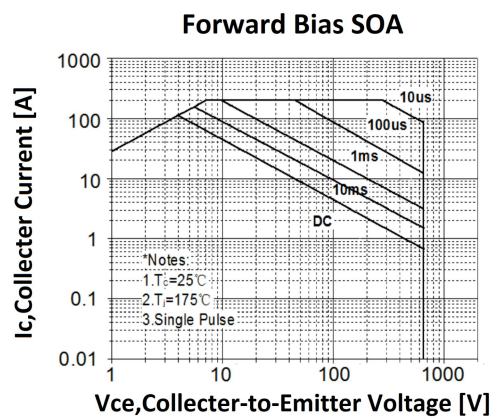
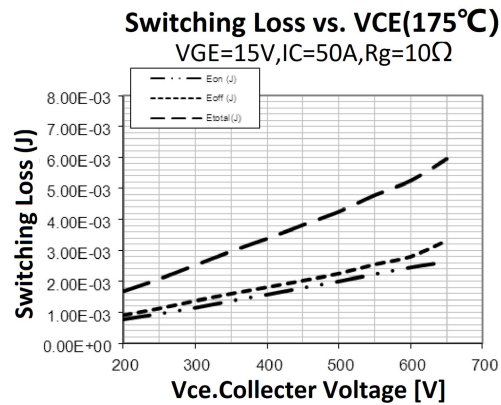
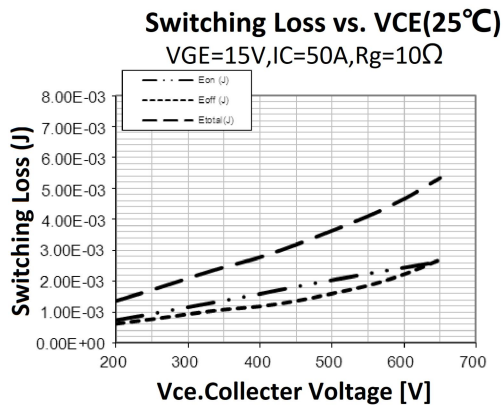
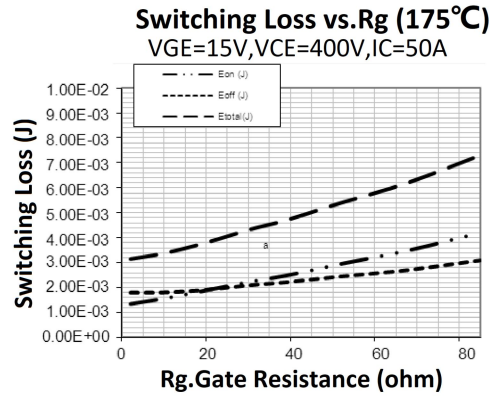
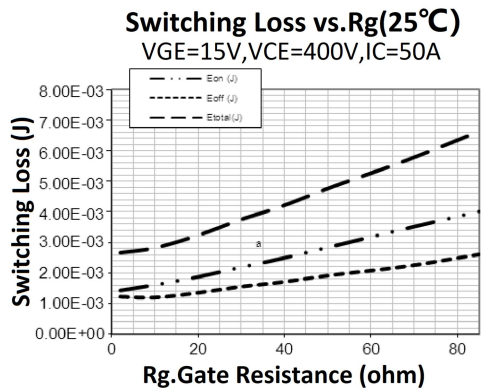

### Normalized Maximum Thermal Impedance for IGBT (RJC)

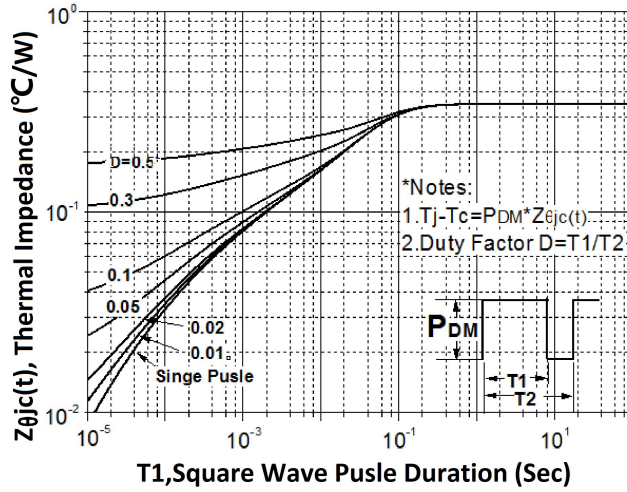

### Package Mechanical DATA

