

ARKLED 无锡市方舟科技电子有限公司
WUXIARK TECHNOLOGY ELECTRONIC CO., LTD

规格(承认)书

Specification for Approval

※ 方舟 P/N (ARKLED P/N): SP410801N

※ 客户 P/N (CUSTOMER P/N):

※ 日期 (DATE): 2017 年 04 月 18 日

制定: 刘杰 审核:



地址: 江苏省宜兴市金张渚工业集中区宇龙路 6 号

Add: NO.6, Yulong Road, Golden Zhangzhu Industrial Park, Yixing City, Jiangsu Province, China

电话(Tel): 销售(Sales):0086-510-87341161 87395800

邮箱(Email): 销售(Sales):sales@arkchn.com

传真(Fax): 0086-510-87342800

技术(Tech): 0086-510-87341558

技术(Tech): tech@arkchn.com

网址(Website): www.arkch.com

型号 PART NUMBER:

SP410801N



Page1 / 4

■ 产品特征 FEATURES:

- 高可靠性和高稳定性

High intensity and reliability

- 高品质、和低功耗、低成本

High quality, Low power requirement and low cost

- IC 易兼容、易装配

IC compatible, Easy assembly

- 符合 RoHS 指令要求

Meet RoHS EU Directive

- 静电承受能力 1000V (HBM)
- ESD 1000V (HBM)

■ 产品描述 DESCRIPTION:

- 三位数码管 Three digits 7 segment LED display

- 极性:共阳 Common Anode

- 表面颜色 Surface Color: 黑面 Black surface

- 笔段颜色: 黄胶 Yellow segment

- 发光颜色 luminous Color:

1、红色 Red

2、选择一项。

3、选择一项。

4、选择一项。

5、选择一项。

- 晶片材质

1、AlGaInP

2、选择一项。

3、选择一项。

4、选择一项。

5、选择一项。

型号 PART NUMBER:

SP410801N



■ 产品最大绝对参数值 (Ta: 25°C) ABSOLUTE MAXIMUM RATINGS AT Ta=25°C:

PARAMETER 项目	SYMBOL 符号	RED 红色	UNIT 单位
Power Dissipation Per Segment 功耗	PAD	50	mw
Reverse Voltage Per Segment 反向耐压	VR	5	V
Continuous Forward Current Per Segment 最大使用电流	IAF	20	mA
Peak Forward Current Per Segment(Duty-0.1,1KHz) 最大峰值电流	IPF	60	mA
Operating Temperature Range 工作温度	TOPr	-20°C to 70°C	
Storage Temperature Range 贮藏温度	Tstg	-20°C to 80°C	
Lead Soldering Temperature 260°C at 1.6mm From Body for 3 second 焊接温度 260°C/3 秒 距离胶体 1.6mm 以上			

■ 产品光电参数值 (Ta: 25°C) ELECTRICAL/OPTICAL CHARACTERISTICS AT Ta=25°C:

PARAMETER 项目	SYMBOL 符号	TEST CONDITION 测试条件	Color 颜色	MIN 最小 值	TYP 标准值	MAX 最大值	UNIT 单位
Forward Voltage ,Per Segment 正向压降	VF	IF=20mA	红色 RED	1.8	2	2.5	V
Reverse Current , Per Segment 反向漏电流	IR	VR=5V	红色 RED			50	µA
Dominant wavelength 主波长	λD	IF=20mA	红色 RED	630	635	637	nm
Luminous Intensity Per Segment 法向光强	IV	IF=20mA	红色 RED	30		37	mcd

型号 PART NUMBER:

SP410801N



■光电曲线图 TYPICAL ELECTRO-OPTICAL CHARACTERISTICS CURVES

RELATIVE INTENSITY VS. WAVELENGTH

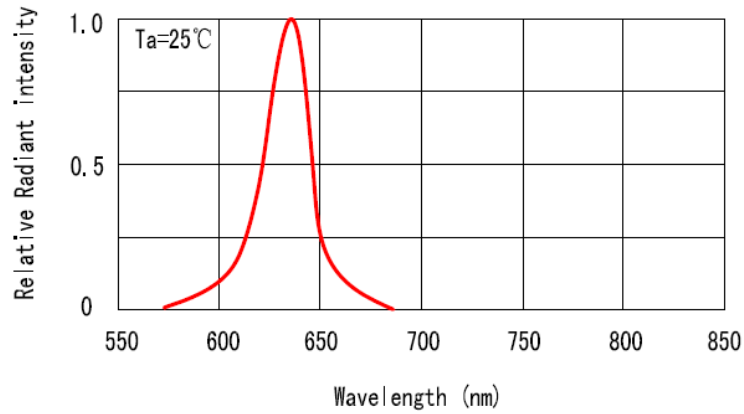

FORWARD CURRENT VS. FORWARD VOLTAGE

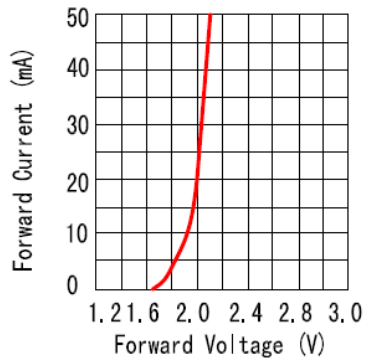

LUMINOUS INTENSITY VS. FORWARD CURRENT

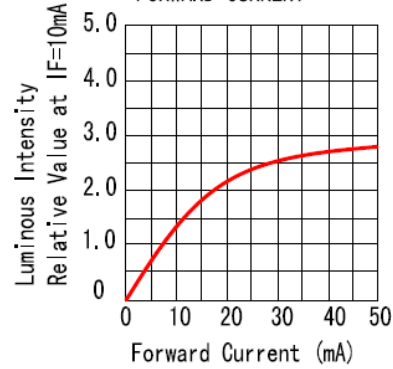

ALLOWABLE FORWARD CURRENT AMBIENT TEMPERATURE

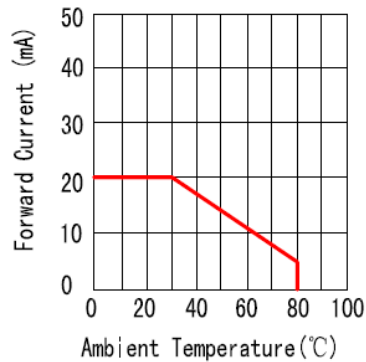

LUMINOUS INTENSITY VS. AMBIENT TEMPERATURE

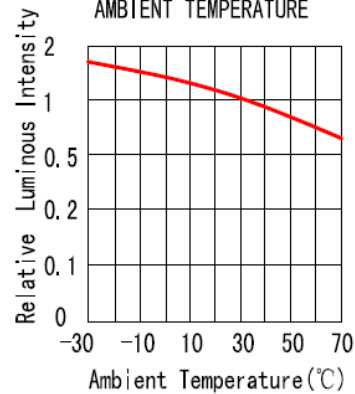

型号 PART NUMBER:

SP410801N



产品尺寸和原理图 DIMENSION AND DIAGRAM

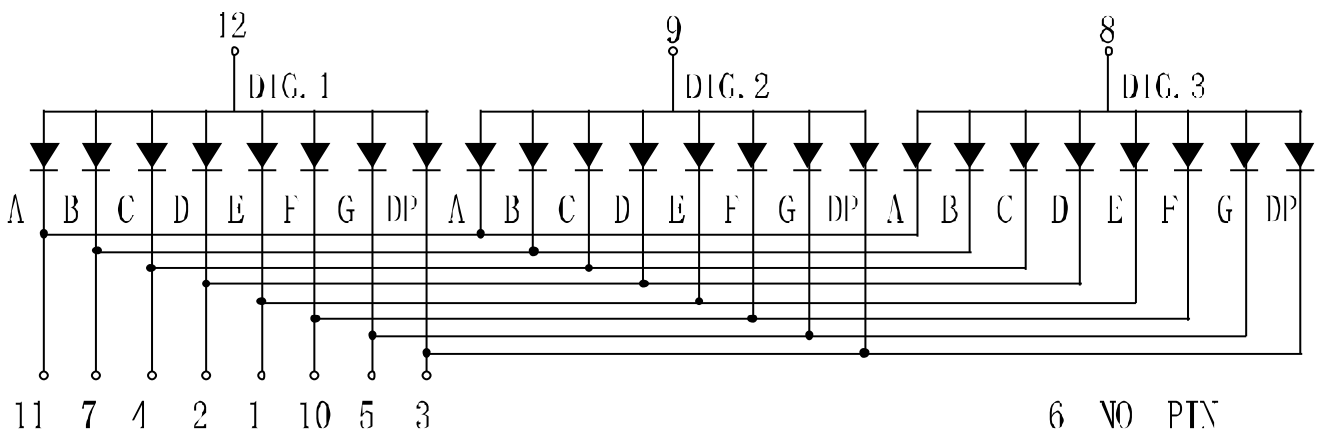
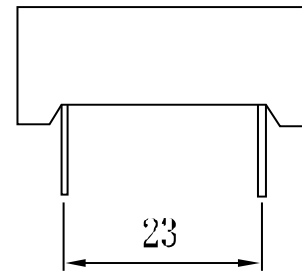
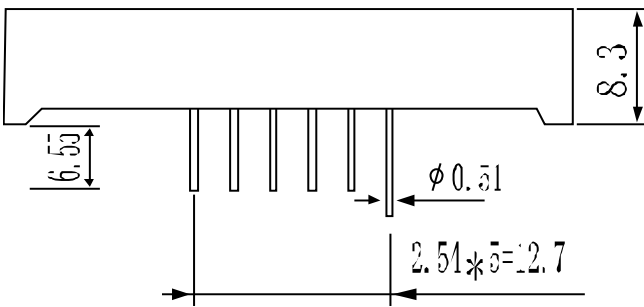
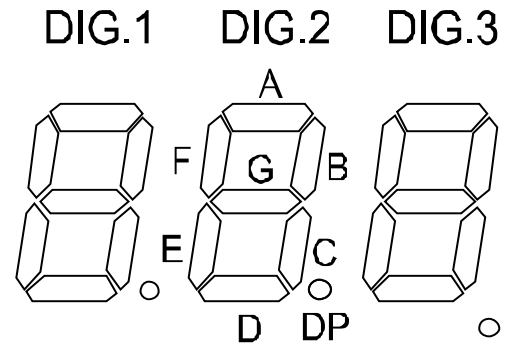
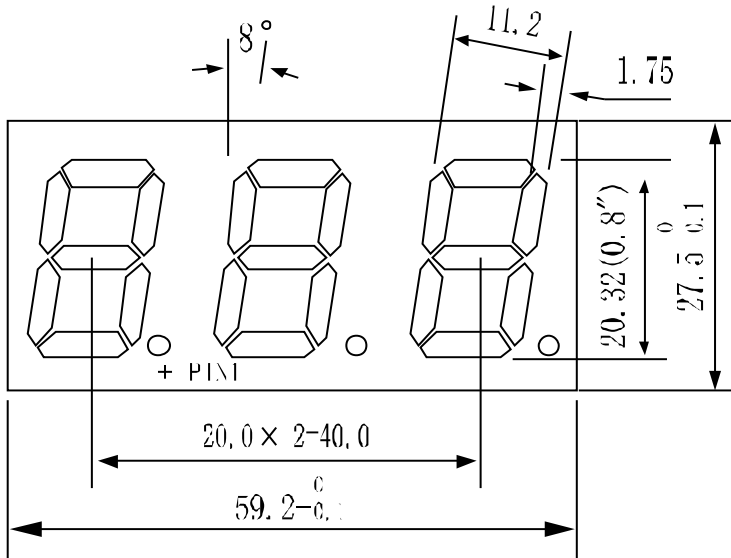

NOTES : 1.单位为毫米. All dimensions are in millimeters. (Inches)

2. 误差一般为±0.25. Tolerance is ±0.25(0.010") unless otherwise specified.